

LXI CORP.

MMS[®] / *tms* - Tape Management

for the iSeries

Software : MMS/*tms*

Documentation : November 2006, LXI Corp. All rights reserved.

Copyright © 1985, 2006 LXI Corp. All rights reserved.

This version of the MMS/*tms* software is compatible with Releases V5R2 and above of the IBM OS/400 Operating System. This product could be affected by future releases of OS/400.

IBM or LXI Corp. makes no warranties or representations as to the quality of this code. The code is offered AS IS AND ALL WARRANTIES, EXPRESSED OR IMPLIED, INCLUDING, BUT NOT LIMITED TO, THE IMPLIED WARRANTIES OF MERCHANTABILITY AND FITNESS FOR A PARTICULAR PURPOSE, ARE SPECIFICALLY DISCLAIMED. In no event shall IBM or LXI Corp. be liable for special, consequential or incidental damages or lost profits, even if advised of the possibility thereof.

No part of this manual covered by the copyrights may be reproduced or copied in any form or by any means - graphic, electronic, or mechanical, including photocopying, recording, or information storage and retrieval systems - without the prior written permission of LXI Corp.

Address any written comments about this document to: LXI Corp., 1925 W. John Carpenter Freeway, Suite 485, Irving, TX 75063, USA. If you wish to fax information the number is (214) 260-9019. If you wish to transmit these comments electronically over the Internet, the address is main@lxicorp.com. You can also submit comments via the World Wide Web at the LXI Corp. web address, <http://www.lxicorp.com>. The company's main voice number is (214) 260-9002.

LXI Corp. may use or distribute any of the information you supply in any way it believes appropriate without incurring any obligations whatsoever.

MMS is a registered trademark of LXI Corp.

LXI Corp. is a registered trademark.

iSeries and OS/400 are trademarks of IBM Corporation.

IBM is a registered trademark of International Business Machines Corporation.

StorageTek is a registered trademark of Storage Technology Corporation

Tape Management

© LXI Corp.
1925 W. John Carpenter Freeway
Suite 485
Irving, Texas 75063
Phone 214.260.9002 • Fax 214.260.9019

Table of Contents

| | |
|--|-----|
| CHAPTER 1 | 1-1 |
| INTRODUCTION | 1-1 |
| Why You Should Use MMS/tms | 1-1 |
| Flexibility When You Need It | 1-1 |
| How This Book Is Organized | 1-2 |
| Conventions Used | 1-3 |
| Command Keys | 1-3 |
| Online Help | 1-4 |
| Before You Install | 1-5 |
| Unique Volume Identifiers | 1-5 |
| Expiration Date Calculations | 1-5 |
| Media and Storage Extension (MSE) | 1-5 |
| Command Security | 1-5 |
| System Defaults | 1-5 |
| IBM Commands | 1-6 |
| MMS/tms Performance | 1-6 |
| Creating Unique Volume Identifiers | 1-6 |
| Expiration Dates | 1-6 |
| CHAPTER 2 | 2-1 |
| FEATURES AND FUNCTIONS | 2-1 |
| Automatic Tape Tracking | 2-1 |
| Tape Protection | 2-1 |
| Automatic Device Management | 2-1 |
| Network Management | 2-1 |
| Retention Support | 2-2 |
| Job Labels | 2-2 |
| Tape Pool Support | 2-2 |
| Data Retrieval Options | 2-2 |
| Non-Labeled Tape Support | 2-2 |
| Volume Security | 2-3 |
| Audit Trail | 2-3 |
| Device Monitor | 2-3 |
| Scratch Forecasting | 2-3 |
| Tape Library Support | 2-3 |
| Message Monitoring | 2-4 |
| Restoration Support | 2-4 |
| Command Access | 2-4 |
| Easy to Use Menus | 2-4 |
| Job Scheduler Interface | 2-4 |

| | |
|---|------|
| CHAPTER 3 | 3-1 |
| CONCEPTS | 3-1 |
| Job Labels..... | 3-1 |
| Getting Tapes into MMS/tms | 3-2 |
| Active Files and MMS/tms..... | 3-2 |
| CHAPTER 4 | 4-1 |
| MENUS | 4-1 |
| Menu Groups..... | 4-1 |
| Menu Security | 4-1 |
| Menu Bars | 4-2 |
| GUI Menus | 4-2 |
| CHAPTER 5 | 5-1 |
| GETTING STARTED..... | 5-1 |
| CHAPTER 6 | 6-1 |
| MANAGING DEVICES..... | 6-1 |
| Device Management Overview | 6-1 |
| Working with Device Definitions | 6-2 |
| Adding Device Definitions | 6-2 |
| Changing Device Definitions | 6-2 |
| Deleting Device Definitions..... | 6-2 |
| Auto-Configuring Devices..... | 6-3 |
| Working with Tape Usage..... | 6-4 |
| Changing Tape Usage Attributes | 6-4 |
| Device Sharing Concepts | 6-5 |
| The Allocation Process | 6-5 |
| The De-allocation Process..... | 6-5 |
| Implementing Device Sharing..... | 6-5 |
| Allocate/De-allocate Examples | 6-6 |
| Initialization Concepts..... | 6-6 |
| Initialization Concepts..... | 6-7 |
| Media Initialization Requirements | 6-7 |
| The MMS/tms INZTAP Command..... | 6-7 |
| The Initialize Process..... | 6-8 |
| Initializing *NL Tapes | 6-8 |
| MMS/tms INZTAP Examples | 6-9 |
| Monitoring Devices | 6-10 |
| CHAPTER 7 | 7-1 |
| RETENTION MANAGEMENT | 7-1 |
| Retention Management Overview | 7-1 |
| Retention Types..... | 7-2 |
| Retention by Days..... | 7-2 |
| Retention by Generations..... | 7-2 |
| Retention by Generations/Days | 7-2 |
| Working with Retention Attributes | 7-3 |
| Adding Retention Attributes | 7-3 |
| Changing Retention Attributes..... | 7-3 |
| Deleting Retention Attributes | 7-3 |
| Generation Considerations | 7-3 |
| Generation Considerations | 7-4 |
| Retention Requirements..... | 7-5 |

| | |
|---|------|
| Establishing Job Retention | 7-5 |
| The Cycle Volume Command..... | 7-5 |
| Cycle Volume Example..... | 7-6 |
| The Submit Job Command..... | 7-7 |
| Submit Job Example..... | 7-7 |
| Retention Hierarchy..... | 7-8 |
| C H A P T E R 8 | 8-1 |
| USING TAPE POOLS | 8-1 |
| Tape Pool Overview | 8-1 |
| Working with Tape Pool Attributes | 8-2 |
| Mounting Options | 8-2 |
| Adding Job Pools | 8-2 |
| Adding Job Pools | 8-3 |
| Changing Job Pools | 8-3 |
| Job Pool Example..... | 8-3 |
| Adding Device/Density Pools | 8-4 |
| Changing Device Pools | 8-4 |
| Device Pool Example..... | 8-4 |
| C H A P T E R 9 | 9-1 |
| VOLUME MANAGEMENT..... | 9-1 |
| Volume Management Overview..... | 9-1 |
| Volume Management Commands | 9-2 |
| Adding a Volume | 9-2 |
| Changing Volume Attributes..... | 9-3 |
| Changing the Job Label..... | 9-3 |
| Changing the Expiration Date | 9-3 |
| Changing the Text..... | 9-3 |
| Clearing a Volume..... | 9-3 |
| Deleting a Volume | 9-4 |
| Displaying Volume Information | 9-4 |
| Displaying Volume Contents..... | 9-4 |
| Displaying Volume History..... | 9-5 |
| Duplicating a Volume..... | 9-5 |
| Retrieving a Volume | 9-5 |
| Volume Security | 9-6 |
| C H A P T E R 10 | 10-1 |
| THE MMS/TMS NETWORK..... | 10-1 |
| Communication Overview..... | 10-1 |
| Communication Types | 10-2 |
| Determining Which to Use..... | 10-2 |
| Communication Differences | 10-2 |
| Working with Communication Links | 10-3 |
| Adding a Communication Link..... | 10-3 |
| Changing a Communication Link | 10-3 |
| Deleting a Communication Link..... | 10-4 |
| Testing a Communication Link..... | 10-4 |
| Comparing Remote Databases..... | 10-4 |
| Starting a Communication Link | 10-5 |
| Ending a Communication Link..... | 10-5 |
| Viewing Communication Transactions..... | 10-5 |
| CPIC Requirements | 10-6 |
| The Communication Profile..... | 10-6 |

| | |
|--|-------|
| TCP/IP Requirements..... | 10-7 |
| The Communication Journal..... | 10-8 |
| The QLXI Subsystem..... | 10-8 |
| Starting the Subsystem..... | 10-8 |
| Ending the Communication Subsystem..... | 10-8 |
| Communication Examples..... | 10-9 |
| Connecting the iSeries using CPIC..... | 10-9 |
| Connecting the iSeries using TCP/IP..... | 10-10 |
| Connecting the iSeries with Unix using TCP/IP..... | 10-11 |
| CHAPTER 11..... | 11-1 |
| RECOVERY..... | 11-1 |
| Recovery Overview..... | 11-1 |
| Working with Saved DLO..... | 11-2 |
| Restoring a Saved DLO..... | 11-2 |
| Working with Saved IFS..... | 11-3 |
| Restoring a Saved IFS..... | 11-3 |
| Working with Saved Object..... | 11-4 |
| Restoring a Saved Object..... | 11-4 |
| Restore Considerations..... | 11-5 |
| Restoring from a Remote Save..... | 11-5 |
| Using the Recovery Report..... | 11-5 |
| CHAPTER 12..... | 12-1 |
| CUSTOMIZING MMS/TMS..... | 12-1 |
| MMS/tms Customization Overview..... | 12-1 |
| MMS/tms Options..... | 12-2 |
| Enhanced Command Support..... | 12-2 |
| Default Location Name..... | 12-2 |
| Default Retrieval Level..... | 12-2 |
| Non-labeled Tape Support..... | 12-3 |
| Local Host Name..... | 12-3 |
| Local Internet Address..... | 12-3 |
| Local Port Number..... | 12-3 |
| Remote Port Number..... | 12-3 |
| Communications Recovery Wait..... | 12-3 |
| Customizing MMS/tms..... | 12-4 |
| Changing Options..... | 12-4 |
| Command Changes..... | 12-4 |
| CHAPTER 13..... | 13-1 |
| USING DATA RETRIEVAL..... | 13-1 |
| Data Retrieval Level Overview..... | 13-1 |
| Retrieval Level Requirements..... | 13-2 |
| DLO Support..... | 13-2 |
| Integrated File System Support..... | 13-2 |
| Lotus Notes/Domino Support..... | 13-2 |
| Object Support..... | 13-2 |
| Save File Support..... | 13-2 |
| Default Retrieval Level..... | 13-3 |
| Job Retrieval Level..... | 13-3 |
| Specifying *USRDFN..... | 13-3 |
| Working with Job Retrieval Levels..... | 13-4 |
| Changing the Job Retrieval Level..... | 13-4 |
| Working with *USRDFN Levels..... | 13-5 |

| | |
|---|-------|
| Adding Library Retrieval Level | 13-5 |
| Changing Library Retrieval Level..... | 13-5 |
| Deleting Library Retrieval Level | 13-5 |
| Retrieval Level Examples | 13-6 |
| Job Retrieval Level Example | 13-6 |
| Library Retrieval Level Example..... | 13-7 |
| Performance Considerations | 13-9 |
| File Size Considerations | 13-9 |
| Retrieval Levels and Outfiles..... | 13-9 |
| C H A P T E R 1 4 | 14-1 |
| USING TAPE LIBRARIES | 14-1 |
| Tape Library Support Overview | 14-1 |
| Device Definition Requirements..... | 14-2 |
| Ejecting Volumes from Tape Libraries | 14-2 |
| Synchronizing Tape Libraries | 14-2 |
| StorageTek Considerations | 14-2 |
| Working with Tape Libraries..... | 14-3 |
| Ejecting Volumes | 14-3 |
| Displaying Volume Contents | 14-3 |
| Initialize Tape | 14-3 |
| Display Tape..... | 14-3 |
| Dump Tape..... | 14-3 |
| Duplicate Tape | 14-4 |
| Check Tape | 14-4 |
| IBM Tape Library Configuration..... | 14-5 |
| Synchronizing the IBM Library..... | 14-8 |
| MTX Tape Library Configuration | 14-9 |
| Synchronizing the MTX Tape Library | 14-13 |
| Restricted State Considerations..... | 14-13 |
| Updating the MTX Server | 14-13 |
| STK - Direct Attach Configuration..... | 14-14 |
| Restricted State Considerations – STK - Direct Attach | 14-16 |
| STK - Server Attach Configuration..... | 14-17 |
| Synchronizing the STK– Server Attach..... | 14-20 |
| STK Library Station Configuration | 14-21 |
| Synchronizing the Library Station Attach STK | 14-24 |
| C H A P T E R 1 5 | 15-1 |
| AUDITING MMS/TMS | 15-1 |
| MMS/tms Audit Overview..... | 15-1 |
| Displaying LXI History Messages..... | 15-2 |
| Scanning the History Log..... | 15-3 |
| Using the Scan Log Command | 15-3 |
| Using the Scan Log Command | 15-3 |
| C H A P T E R 1 6 | 16-1 |
| MMS/TMS REPORTS | 16-1 |
| Accessing the Report Menu..... | 16-2 |
| Printing Reports | 16-2 |
| Changing Printer File Attributes | 16-3 |
| Changing Printer Attributes..... | 16-3 |
| Scheduling Reports | 16-4 |
| Adding Scheduled Reports | 16-4 |
| Changing Scheduled Reports..... | 16-4 |

| | |
|--|-------|
| Deleting Scheduled Reports | 16-4 |
| Communication Link Report..... | 16-5 |
| Communication Link Details Report | 16-6 |
| Compare Volume Report..... | 16-7 |
| Job Label Report | 16-8 |
| Recovery Report by Job Label..... | 16-9 |
| Recovery Report by Library..... | 16-10 |
| Saved DLO Report | 16-11 |
| Saved Objects Report..... | 16-12 |
| Saved Links Report..... | 16-13 |
| Scan Log Report..... | 16-14 |
| Scratch Report | 16-15 |
| Tape Device Report..... | 16-16 |
| Tape Library Report..... | 16-17 |
| Tape Usage Report..... | 16-18 |
| MMS/tms Audit Log Report..... | 16-19 |
| Volume Report | 16-20 |
| Volume Data Report..... | 16-21 |
| Volume Information Report..... | 16-22 |
| Volume Label..... | 16-23 |
| Volume Status Report..... | 16-24 |
| CHAPTER 17 | 17-1 |
| TAPE MANAGEMENT COMMANDS..... | 17-1 |
| ADDCMNLNK - Add Communication Link | 17-2 |
| ADDJOBLBL - Add Job Label | 17-6 |
| ADDRTVLVL - Add Retrieval Level..... | 17-12 |
| ADDTAPDEV - Add Tape Device..... | 17-14 |
| ADDEVOL - Add Volume..... | 17-17 |
| ALCTAPDEV - Allocate Tape Device..... | 17-19 |
| CHGCMNLNK - Change Communication Link..... | 17-21 |
| CHGJOBLBL - Change Job Label..... | 17-24 |
| CHGPRDOPT - Change Product Options | 17-30 |
| CHGPRDSTS - Change Product Status | 17-33 |
| CHGRTVLVL - Change Retrieval Level..... | 17-34 |
| CHGTAPDEV - Change Tape Device..... | 17-36 |
| CHGTAPLIB - Change Tape Library..... | 17-39 |
| CHGTAPUSG - Change Tape Usage..... | 17-41 |
| CHGVOL - Change Volume | 17-45 |
| CHGVOLSEC - Change Volume Security..... | 17-47 |
| CLRVOL - Clear Volume | 17-48 |
| CMPVOL - Compare Volume | 17-49 |
| CYCLE - Cycle Volume..... | 17-50 |
| DLCTAPDEV - De-allocate Tape Device..... | 17-52 |
| DLTCMNLNK - Delete Communication Link | 17-53 |
| DLTJOBLBL - Delete Job Label..... | 17-54 |
| DLTRTVLVL - Delete Retrieval Level | 17-55 |
| DLTTAPDEV - Delete Tape Device | 17-56 |
| DLTVOL - Delete Volume | 17-57 |
| DSPCMNLNK - Display Communication Link | 17-58 |
| DSPJOBLBL - Display Job Label..... | 17-59 |
| DSPSAVDLO - Display Saved DLO | 17-60 |
| DSPSAVLNK - Display Saved Link | 17-64 |
| DSPSAVOBJ - Display Saved Object..... | 17-68 |
| DSPVOL - Display Volume | 17-72 |

| | |
|--|--------|
| DSPVOLDTA - Display Volume Data | 17-77 |
| DSPVOLFMT - Display Volume Format | 17-78 |
| DSPVOLINF - Display Volume Information | 17-79 |
| DUPVOL – Duplicate Volume | 17-80 |
| EJTVOL – Eject Volume | 17-83 |
| ENDCMNLNK - End Communication Link | 17-86 |
| ENTVOL – Enter Volume | 17-87 |
| INZTAP - Initialize Tape | 17-88 |
| PRTRCYVOL - Print Recovery Volumes | 17-92 |
| PRTVOLLBL - Print Volume Label | 17-94 |
| PRTVOLSTS - Print Volume Status | 17-95 |
| RTVJOBLBL - Retrieve Job Label | 17-96 |
| RTVVOL - Retrieve Volume | 17-98 |
| SCNLOG - Scan History Log | 17-100 |
| STRCMNLNK - Start Communication Link | 17-103 |
| TSTCMNLNK - Test Communication Link | 17-104 |
| UPDLIBSVR – Update Library Server | 17-105 |
| UPDTAPLIB – Update Tape Library | 17-106 |
| WRKCMNLNK - Work with Communication Link | 17-107 |
| WRKJOBLBL - Work with Job Label | 17-108 |
| WRKPRTF - Work with Printer Files | 17-109 |
| WRKRTVLVL - Work with Retrieval Level | 17-110 |
| WRKSAVDLO - Work with Saved DLO | 17-111 |
| WRKSAVLNK – Work with Saved Link | 17-115 |
| WRKSAVOBJ - Work with Saved Object | 17-119 |
| WRKTAPDEV - Work with Tape Device | 17-123 |
| WRKTAPLIB - Work with Tape Library | 17-124 |
| WRKTAPSTS - Work with Tape Status | 17-127 |
| WRKTAPUSG - Work with Tape Usage | 17-128 |
| WRKVOL - Work with Volume | 17-129 |
| | |
| C H A P T E R 1 8 | 18-1 |
| INSTALL/UNINSTALL INSTRUCTIONS | 18-1 |
| Install Process | 18-1 |
| Upgrading OS/400 | 18-1 |
| Changing the iSeries | 18-1 |
| Uninstall Process | 18-2 |
| Entering the License Key | 18-2 |
| Trial Period | 18-2 |
| Permanent License Key | 18-2 |
| | |
| C H A P T E R 1 9 | 19-1 |
| ADVANCED TOPICS | 19-1 |
| The QLXI Subsystem | 19-1 |
| MMS/tms and SAVSTG | 19-1 |
| Reorganizing the Database | 19-1 |
| Clearing the Database | 19-2 |
| Saving the Database | 19-2 |
| Modifying Option 21 | 19-2 |
| Modifying the MMS/tms Message File | 19-3 |
| Last Used Date | 19-3 |
| Disaster Recovery Considerations | 19-3 |
| Setting up DDM over TCP/IP | 19-4 |

| | |
|--|------|
| CHAPTER 20 | 20-1 |
| MMS/TMS AND TSM..... | 20-1 |
| Defining the Exit Programs..... | 20-1 |
| Special Implementation Considerations..... | 20-3 |
| CHAPTER 21 | 21-1 |
| ADDITIONAL INTERFACES..... | 21-1 |
| BrightStor® Portal..... | 21-1 |
| EMC CopyPoint®..... | 21-1 |
| Install Process..... | 21-1 |
| Uninstall Process..... | 21-1 |
| EMC Interface Considerations | 21-2 |
| CHAPTER 22 | 22-1 |
| TROUBLESHOOTING GUIDE..... | 22-1 |
| CHAPTER 23 | 23-1 |
| ELECTRONIC SOFTWARE SUPPORT..... | 23-1 |
| Setting up ESS..... | 23-2 |
| Updating the Configuration Data | 23-2 |
| Requesting Online Support..... | 23-3 |
| ESS Considerations..... | 23-3 |
| Index..... | 23-1 |

NOTICES

References in this publication to LXI Corp. products, programs, or services do not imply that LXI Corp. intends to make these available in all countries in which LXI Corp. operates. Any reference to any LXI Corp. product, program, or service is not intended to state or imply that only LXI Corp. product, program, or service may be used. Subject to LXI Corp.'s intellectual property or other legally protectable rights, any functionally equivalent product, program, or service may be used instead of the LXI Corp. product, program, or service. The evaluation and verification of operation in conjunction with other products, except those expressly designated by LXI Corp. are the responsibility of the user.

LXI Corp. may have patents or pending patent applications covering subject matter in this document. The furnishing of this document does not give you any license to these patents. You can send license inquiries, in writing, to LXI Corp., 1925 W. John Carpenter Freeway, Suite 485, Irving TX 75063, U.S.A.

Licensees of this program who wish to have information about it for the purposes of enabling: (i) the exchange of information between independently created programs and other programs (including this one) and (ii) the mutual use of the information which has been exchanged, should contact the LXI Corp. R&D coordinator. Such information may be available, subject to appropriate terms and conditions, including in some cases, payment of a fee.

Address your questions to:

LXI Corp.

1925 W. John Carpenter Freeway

Suite 485

Irving, TX 75063 USA

This publication could contain technical inaccuracies or typographical errors.

This publication may refer to products that are announced but not currently available in your country. This publication may also refer to products that have not been announced in your country. LXI Corp. makes no commitment to make available any unannounced products referred to herein. The final decision to announce any product is based on LXI Corp.'s business and technical judgment.

This publication contains examples of data and reports used in daily business operations. To illustrate them as completely as possible, the examples include the names of individuals, companies, brands, and products. All of these names are fictitious and any similarity to the names and addresses used by an actual business enterprise is entirely coincidental.

This publication contains small programs that are furnished by LXI Corp. as simple examples to provide an illustration. These examples have not been thoroughly tested under all conditions. LXI Corp., therefore, cannot guarantee or imply reliability, serviceability, or function of these programs. All programs contained herein are provided to you "AS IS." THE IMPLIED WARRANTIES OF MERCHANTABILITY AND FITNESS FOR A PARTICULAR PURPOSE ARE EXPRESSLY DISCLAIMED.

Chapter 1

Introduction

Effective tape management is critical to data centers since it is the insurance policy that helps ensure that data is not destroyed by accidental or intentional misuse. Unlike mirroring or other high-availability products, tape management retains information from all prior backups, which is crucial when searching for an object based on a specific date/time. This vast wealth of information helps smooth and simplify the chaos caused by a disaster. Tape management helps keep the backup window small by allocating tape devices and ensuring that no job waits for a device when other devices are available. Tape management automatically manages and mounts the required tapes in automated tape libraries. Tape management prevents unauthorized users from restoring sensitive information. Tape management ensures that the correct retention policies for corporate data are adhered to. Tape management tells you where important information is located and keeps that information secure. The MMS Tape Management module (MMS/*tms*) is a subset of the LXI Media Management System (MMS). This module is designed to help you set up and maintain an effective tape management strategy across networked systems that protects and organizes a corporation's most precious resource - data.

Why You Should Use MMS/*tms*

Many reasons exist for choosing MMS/*tms*, including its wide array of features and functions, ease of implementation, power, flexibility, and ease of use. For those of you familiar with other LXI products, the choice of MMS Tape Management is easy. MMS/*tms* can increase productivity and help eliminate errors caused by old, outdated and incomplete tape management strategies. The flexibility provided allows you to customize and change your strategy as required without having to modify existing code. The strategy that you create today can be reviewed and changed at any time to help ensure that all your requirements are met.

Ease of implementation is key to using any software. MMS Tape Management uses existing IBM facilities and requires no additional modifications to make it function. Since there is no need to change existing code, MMS/*tms* is active and ready to use after the installation procedure has completed.

Flexibility When You Need It

Changes are the forte of any data center, and MMS/*tms* is designed to adapt easily and quickly. The tape management strategy that worked so well yesterday can be updated to meet today's challenges within a few minutes. Retention policies, device characteristics, tape pools, communications, security, and object restoration information is easily maintained in one comprehensive software package.

How This Book Is Organized

This manual is organized to help you set up and use the software as quickly and efficiently as possible. If you are familiar with earlier versions of this product, you should scan the table of contents for new features. This manual is organized as follows:

- **System Overview**
Chapters 2 through 5 outline the MMS/*tms* features and functions. These chapters also provide an explanation of the concepts used. Understanding them ensures successful implementation and use of this product. Chapter 5 contains the Quick Start exercises, which illustrate the simplicity of use.
- **Description of Major Functions**
Chapters 6 through 11 detail all MMS/*tms* functions including device management, retention management, tape pools, volume management, communications and recovery options.
- **Product Customization**
Chapters 12 through 14 provide detailed information on all customization options including non-labeled tape support, Enhanced Command Support, data retrieval levels and tape libraries.
- **Auditing MMS/*tms***
Chapter 15 contains information on the audit log. This log can be used to track all changes within MMS/*tms*.
- **Reports**
Chapter 16 contains a list of all reports, their associated commands and printer files. Example reports are shown.
- **Command References**
Chapter 17 provides a list of all of MMS/*tms* commands, command parameters, and parameter values. This chapter is an important resource for users who prefer to use commands rather than menus.
- **Installation Instructions**
Chapter 18 contains the information required to successfully install this product. Information on license keys is also provided.
- **Troubleshooting Guide**
Chapter 21 lists the most commonly asked questions regarding MMS/*tms* functionality. If MMS/*tms* does not function as expected, this appendix can provide you with valuable insight quickly.

- **Software Support**

Chapter 22 provides instructions for accessing Electronic Software Support from the LXI technical support staff. In the event that you need a Program Temporary Fix (PTF) or online support, this chapter walks you step-by-step through the process of getting help.

Conventions Used

The conventions that are used in this manual have been established to help you learn and use the product quickly and easily.

The first time a function is referenced, it displays in bold type.

Menus, panels, and command prompts are displayed as needed to help explain a function or location of a function.

Default parameters for commands are **bold** and underlined.

Command Keys

To help minimize the time required to learn MMS Tape Management, IBM command key standards have been followed whenever and wherever possible. The following graph shows some of the commands and their use within this product. The command keys available and their associated functions are displayed at the bottom of each menu and panel.

| Command Key | Function | Description |
|-------------|----------|---|
| F1 | Help | Displays cursor-sensitive help text. |
| F3 | Exit | Exits the function and returns to the prior function. |
| F4 | Prompt | Prompts the user for command parameters. |
| F5 | Refresh | Updates the panels with current information. |
| F12 | Cancel | Cancels the requested function. |

Online Help

MMS/*tms* provides online help for all commands, menus, and panels. The help provides additional information on a function or field. To access help, position the cursor on the field or parameter in question and press the **F1** key.

MMS/*tms* error messages may also provide additional information on the cause of the error and the corrective action to take. To retrieve additional message help, place the cursor on the message and press the **F1** key. If second level help is available, it is displayed.

Before You Install

Before installing this product, review the items below. Knowing this information from the beginning simplifies the use of MMS/*tms*.

Unique Volume Identifiers

Any effective tape management requires the use of unique volume identifiers to properly track volume information. If you have used the same volume identifier on more than one volume, MMS/*tms* can still work. For additional information, see [Creating Unique Volume Identifiers](#) in this chapter for a description of how to convert to unique volume identifiers.

Expiration Date Calculations

MMS/*tms* calculates the expiration date for volumes based on the tape attributes established for the job, if supplied. In order for this feature to work, the expiration date for the save/copy commands must be ***PERM**. If a date is used in the save/copy commands, it overrides MMS/*tms*. For additional information, see [Expiration Dates](#) in this chapter for details on changing the IBM default for copy commands.

Media and Storage Extension (MSE)

MMS/*tms* requires the IBM Media and Storage Extension option to OS/400.

Command Security

MMS/*tms* is a command driven software product. All menu and panels options reference either an IBM or a MMS/*tms* command. Command authority is achieved in the same way that authority is established for IBM commands. If a user is not authorized to use an MMS/*tms* command, the function that the restricted command performs will not be available for use and the option number is not displayed. If the user tries to access the command directly via command line, he will receive a message from OS/400 stating that he is not authorized to use the command.

System Defaults

MMS/*tms* command defaults conform to iSeries system defaults, where applicable. Overrides can come from IBM commands as well as MMS/*tms*. In areas where IBM has no matching default, MMS/*tms* uses values that cause the software to use the fewest resources and execute the fastest. If the MMS/*tms* command defaults are changed, it is the users responsibility to maintain the changes during product upgrades.

IBM Commands

MMS/*tms* contains a command set, which is used primarily to create and manage tape management functions. In order to provide additional functionality to some IBM commands, MMS/*tms* will duplicate them. The modified IBM commands reside in library LXITMS.

MMS/tms Performance

MMS/*tms* performance is based on (1) the product options selected, and (2) the efficiency of the users backup programs. If object or member level information is specified, additional disk space and processing resources are used. To minimize the effect of this type of processing, the users backup programs must be written efficiently. Backing up one library at a time through a CL program slows down OS/400 as well as MMS/*tms*. To maximize throughput and minimize processing time, IBM save commands should save as many objects as feasible in one execution of the command.

Creating Unique Volume Identifiers

MMS/*tms* requires unique volume identifiers to track and manage tape volumes. If unique volume identifiers do not exist, it is recommended that tapes be re-initialized with a unique volume identifier as they become available for reuse.

Expiration Dates

MMS/*tms* calculates the expiration date for volumes based on user requirements. In order for this feature to work correctly, the expiration date on the tape command being used must be ***PERM**. The default for IBM tape copy commands is ***NONE**. If this value is **not** changed, the expiration date for any volume created with the tape file will be 01/01/00. To change the tape file, enter the following:

```
CHGTAPF FILE(library/tape file name) EXPDATE(*PERM)
```

Chapter 2

Features and Functions

This chapter documents some of the most important features in MMS Tape Management. If you are an experienced user, browse through this chapter to find what has changed and what features have been added. Changes in MMS/*tms* are of two types: those that enhance existing features or make them easier to use, and those that add flexibility and power to MMS/*tms*.

Automatic Tape Tracking

MMS/*tms* starts tracking tapes as soon as the software is installed and attached to OS/400. Tapes are tracked and added to the database immediately when they are used for save, restore, copies, archives or other purposes. MMS/*tms* requires no special enrollment schemes or other proprietary product setup procedures. There is no need to add volumes to the database prior to use. If unique volume identifiers are used, they are tracked and protected.

Tape Protection

MMS/*tms* starts protecting tapes immediately. Tapes with active files cannot be used. If an active tape is found in a standalone device, it is unloaded. If it's found in an automated tape library, it is unloaded and replaced with another tape.

Automatic Device Management

MMS/*tms* automatically allocates available tape devices to waiting jobs. This provides a method of sharing tape devices with multiple systems or jobs. This feature also manages the drives in Automated Tape Libraries (ATL).

Network Management

MMS/*tms* supports virtually limitless iSeries systems within a network. Data is automatically sent to all remotes. Remote systems that are off-line are by-passed until they go online. Information from systems in restricted state is queued. Communication recovery and verification ensures that information reaches every remote system and provides the assurance that the remotes are updated. MMS/*tms* also provides communication support to other LXI open systems tape management products.

Retention Support

MMS/*tms* provides three types of retention. Volume expiration dates can be set by establishing a number of days that must elapse before a volume can be reused; by establishing the number of generations that must exist before volumes are reused; or a combination of both. If an expiration date is calculated by MMS/*tms*, it is written to tape to ensure that the volume is protected no matter where it goes.

Job Labels

MMS/*tms* establishes tape job attributes through Job Labels. The attributes that can be specified include data retention, volume text, data retrieval levels, and tape pool requirements. Job Labels help ensure that the same attributes are used whenever the same data is saved. This helps ensure consistency and accuracy in data protection.

Tape Pool Support

MMS/*tms* tape pool support helps ensure that the right tapes are used for jobs having specific tape requirements. Tape pool support is available for Automated Tape Libraries as well as stand-alone tape devices. Tape pools can be specified in the Job Label, Device Definition or both and can be used for some jobs and not for others. Options include rejecting tapes that do not meet the requirements of the job.

Data Retrieval Options

MMS/*tms* provides virtually limitless options in determining the amount of volume content information to retrieve. Options include data retrieval at library, object, or member levels. Additional options allow you to select the retrieval level at Job Label or library level. MMS/*tms* also provides content information for saved save files, Document Library Objects (DLO), Integrated File System objects (IFS) and objects saved by the MMS client.

Non-Labeled Tape Support

MMS/*tms* provides basic non-labeled tape support allowing you to track and manage non-labeled tapes. With non-labeled tape support, the volume information, as well as basic volume content information, is tracked in the database.

Volume Security

MMS/*tms* provides read, write, or read/write protection. This protection, if applied, is sent to all systems within the MMS/*tms* network to help ensure that the volume remains secure regardless of the system being used. Volumes, which have been secured, cannot be modified by any MMS/*tms* command. This helps ensure the integrity of secured volumes.

Audit Trail

MMS/*tms* provides an audit trail of virtually all MMS/*tms* functions. This information is written to the system history log and can be viewed, or printed, by using the MMS/*tms* audit log functions. Message information includes the function performed as well as the job, user, number, date, and time.

Device Monitor

MMS/*tms* provides a device monitor that scans all active tape devices and displays the status, as well as volume currently being used. The screen is automatically refreshed to show you the current information. If a device has a message pending, the display highlights the device, allowing you to view and answer the message. This helps minimize delays caused by devices waiting for tapes or other messages requiring a response.

Scratch Forecasting

MMS/*tms* provides the ability to forecast the number of scratch tapes that are available at any point in time. This feature can be used to ensure that an ample number of tapes are available before you need them.

Tape Library Support

MMS/*tms* provides support for IBM, Memorex/Telex and StorageTek automated tape libraries. This support manages multiple libraries at the same time as well as libraries shared between multiple systems. Options include the ability to verify library contents as well as determine the number of active or scratch tapes within a library.

Message Monitoring

MMS/*tms* can automatically answer tape-related messages without operator intervention. This feature helps automate production by letting MMS/*tms* monitor and answer tape messages.

Restoration Support

MMS/*tms* simplifies the restoration of any objects saved by MMS/*tms*. Extensive selection criteria simplifies the search process. Once the correct version of an object is selected for restoration, MMS/*tms* prompts for the correct media and restores the object. If the tape is in a tape library, the tape is automatically mounted and the object restored.

Command Access

MMS/*tms* provides complete control over all tape management functions. Volume commands provide the ability to add, change, delete as well as initialize, clear, retrieve, and compare against remote databases. A wide assortment of Work with... commands provide easy access to tape devices, tape usage, Job Labels, communication and volumes. Total control is the key to successfully managing your data and MMS/*tms* commands are designed to provide access to all functions. The users' authority to the commands determines command access.

Easy to Use Menus

MMS/*tms* provides menus to help guide you through the functions. The menus are based on function and provide access to IBM menus when necessary. MMS/*tms* menus include Job Label, Tape, Security, Volume and Communication menus. Each menu provides access to all related commands. The users' authority to the commands determines command access.

Job Scheduler Interface

MMS/*tms* provides an interface to the LXI job scheduler. This scheduler is used for all time-based MMS/*tms* jobs, such as automatic reporting. If the LXI job scheduler is not installed, the standard IBM OS/400 job scheduler is used.

Chapter 3

Concepts

It takes just a few minutes to set up MMS/*tms*. First, create a Job Label that defines the tape job's attributes, such as retention and volume text. Next, perform a tape save or copy that uses the Job Label. Finally view and/or print the results. The basic steps you take in creating the first tape job show you the principles that you will use with every other tape job that you create.

In order to understand the tape management process, it is helpful to understand some of the key concepts upon which MMS/*tms* is built. Because MMS/*tms* is an OS/400 tape management system, some familiarity with OS/400 is necessary. If you are new to the OS/400 environment, you need to be aware of some fundamental differences between tape management for OS/400 versus other environments.

Job Labels

A Job Label is a tape job definition. This definition is associated to the tape function through the Cycle Volume (**CYCLE**) command or through the IBM Submit Job command. When a tape is created, the attributes in the Job Label are used to establish the requirements for the job. The Job Label defines the attributes associated with a tape function such as:

- Data retention
- Volume text
- Tape Pool
- Data retrieval levels

Job Labels provide a common interface to tape management from other LXI MMS modules such as:

- Backup and Recovery Management (MMS/*bms*)
- Container Management and Vaulting (MMS/*vms*)
- Hierarchical Storage Management (MMS/*hsm*)
- Spooled File Management (MMS/*spl*)

Getting Tapes into MMS/*tms*

The fastest way of getting tapes into the database is to use them. Tapes are automatically added as used. If tapes need to be added for other reasons, MMS/*tms* provides two methods of getting them into the database.

The first method allows tapes to be manually added through the Add Volume (**ADDVOL**) command. This command can be used to add tapes from other platforms into the database.

The second method reads the tape and updates the database with the information retrieved from the volume. This is accomplished with the Retrieve Volume (**RTVVOL**) command.

Active Files and MMS/*tms*

MMS/*tms*, if attached and using a valid license key, will not write over a tape with active files unless:

- Tape initialization is performed and the user replies “**INZ**” to the warning message.
- **CLEAR(*ALL)** is specified on the save command.

Except as listed above, any tape having active files is unloaded if one attempts to write on it. If an active file is found in an automated tape library, the tape is unloaded and another tape mounted.

Chapter 4

Menus

MMS/*tms* is a command driven product. As such, most functions can be easily initiated from an OS/400 command line or from within a high level program. When the product is first installed, the MMS/*tms* menu system provides an easy method of learning the commands associated with a particular function. Over time, as the commands become familiar, the menu system can be bypassed and the commands can be accessed directly.

The menu system is comprised of a main menu and six related command menus. Each command menu provides access to another related command menu. Depending on the function and level of menu currently displayed, the related command menu may be an LXI menu or an IBM menu.

Menu Groups

Menus are grouped by function. The following functions have their own menu.

- Communication Link Commands
- Job Label Commands
- Reports
- Security Commands
- Tape Commands
- Volume Commands

Menu Security

IBM security can be implemented for any MMS/*tms* menu or menu function. If a user is not authorized to a menu, the secured menu will not be displayed as an option from other MMS/*tms* menus. If a user is not authorized to a specific function on a menu, the option and related command will not be displayed. Use the appropriate IBM command to change the authority of a MMS/*tms* menu or command.

Menu Bars

Some menus contain menu bars. Menu bars are located on the top of a menu and are assigned function names. Use the **Tab** key to position the cursor on the desired function. Once the cursor is in place, pressing the **Enter** key lists the options available. If you are using a mouse, double click on the desired function. This provides a list of the options available. Enter the desired option number in the option field provided and press **Enter**.

The following example shows the location of the menu bar on menu MMS/*tms*.

```

Setup  Communications  Go  Help
-----
LXITMS                               Tape                               System:  S1234567

Select one of the following:

    1. Work with Job label
    2. Work with Volume

    10. Reports

Related Command Menu
 80. Communication Link Commands          CMDMNLNK
 81. Job Label Commands                  CMDJOBLBL
 82. Security Commands                   CMDSEC
 83. Tape Commands                       CMDTAP
 84. Volume Commands                     CMDVOL

                                          Bottom

Selection or command
====>
F3=Exit  F4=Prompt F9=Retrieve F12=Cancel
(c) Copyright LXI Corp. 1985, 2006

```

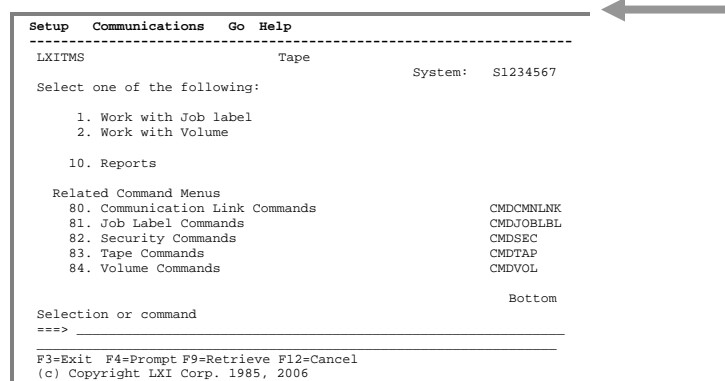

GUI Menus

All menus and panels display in the IBM Graphical User Interface (GUI) format if supported by the display device. This support means that all menus and panels will have a PC look and feel with an easy point-and-click interface. The function keys still work and the command line is available for use.

Chapter 5

Getting Started

In this chapter, you learn how to implement and use the basic functions of MMS/*tms*. If you are a new user to MMS/*tms*, this chapter is important for two reasons: you will become comfortable navigating MMS/*tms*, and you will have a head start on the next MMS program you learn.

Simplicity is the key in getting started. No special commands are required. MMS/*tms* is active once the software is installed and the product is linked to OS/400. Refer to [Chapter 18](#) for installation instructions. Since MMS/*tms* uses standard IBM commands, compatibility with other products is assured.

The purpose of this chapter is to:

- Review the system defaults
- Attach MMS/*tms* to OS/400
- Perform a save
- View the results

The remaining chapters provide additional information on other functions and options available to you.

Step 1.

Since MMS/*tms* has defaults for all system functions, the Quick Start is nothing more than attaching MMS/*tms* to OS/400 and performing a save. The following chart lists the defaults. To change the defaults, refer to the chapter listed under Additional Information. If the defaults are acceptable, continue with Step 2.

| Function | MMS/ <i>tms</i> Default | Additional Information |
|---|-------------------------|----------------------------|
| Data retention for all saves/copies | 90 days | Chapter 7 |
| Non-Labeled Tape Support | *YES | Chapter 12 |
| Volume Content Level (Data Retrieval Level) | *LIB | Chapter 13 |

Step 2.

Ensure that **LXITMS** is in the library list and enter **GO LXITMS**. This displays the LXITMS Tape menu.

Use the **Tab** key to tab to **Setup** on the menu bar. Press **Enter** to display the options available.

Select **Option 1**. This prompts the Change Product Status command.

```

Setup  Communications  Go  Help
-----
: 1 1. Status      :           Tape           System:  S1234567
: 2. Options      :
: .....: following:
      1. Work with Job label
      2. Work with Volume

      10. Reports

Related Command Menus
80. Communication Link Commands      CMDCMNLNK
81. Job Label Commands                CMDJOBLBL
82. Security Commands                 CMDSECC
83. Tape Commands                    CMDTAP
84. Volume Commands                   CMDVOL

                                           Bottom
Selection or command
====>
F3=Exit F4=Prompt F9=Retrieve F12=Cancel F13=Info Assistance
    
```

Step 3.

If the Status is ***DETACH**, change it to ***ATTACH**. This enables MMS/*tms* with the OS/400 operating system.

MMS/*tms* must be attached in order to manage devices and track tape media.

```

Change Product Status (CHGPRDSTS)

Type choices, press Enter.

Product identifier . . . *TMS      *TMS
Status . . . . . *ATTACH  *ATTACH, *DETACH, *SAME

                                           Bottom
F3=Exit F4=Prompt F5=Refresh F12=Cancel F13=How to use this display
F24=More keys
    
```

Step 4.

Perform a save. The save can be interactive, submitted to batch, or in a program.

Step 5.

When the save has completed, select **Option 2** from the Tape menu to display the results of the save performed in Step 4.

```
Setup  Communications  Go  Help
-----
LXITMS                               Tape                               System: S1234567

Select one of the following:

  1. Work with Job label
  2. Work with Volume

10. Reports

Related Command Menus
 80. Communication Link Commands      CMDCMNLNK
 81. Job Label Commands                CMDJOBLBL
 82. Security Commands                 CMDSEC
 83. Tape Commands                     CMDTAP
 84. Volume Commands                   CMDVOL

                                          Bottom

Selection or command
====>

F3=Exit F4=Prompt F9=Retrieve F12=Cancel F13=Info Assistance
(c) Copyright LXI Corp. 1985, 2006
```

Step 6.

If you want to disable MMS/*tms* from OS/400, perform steps 2 and 3, specifying ***DETACH** for the **STATUS** parameter. When detached, MMS/*tms* does not track tapes or manage devices.

See the following pages for detailed information.

Chapter 6

Managing Devices

MMS/*tms* supports any tape device supported by OS/400 including IBM, Memorex/Telex (MTX) and StorageTek (STK) automated tape libraries. The degree of support is based on a user-defined definition called a **Device Definition**. The Device Definition determines if the device can be shared, the initialization formats and starting numbers, tape pool ranges, and tape library configuration.

In order to understand the device management process, it is helpful to understand some of the essential concepts upon which MMS/*tms* is built.

Device Management Overview

MMS/*tms* device management provides the interface between MMS/*tms* and one or more tape devices or automated tape libraries. A Device Definition must exist if the tape media used on the device is to be tracked and managed. Adding devices is easily accomplished by using the MMS/*tms* auto-configuration option, which retrieves all tape devices currently configured on the iSeries, and adds them to the MMS/*tms* database. The Device Definition consists of two parts. The first part defines the device; the second defines density specific attributes.

When a device is accessed, MMS/*tms* searches for that specific Device Definition. If one does not exist, MMS/*tms* will not manage the device or track tape media used on the device.

Working with Device Definitions

Device Definitions define the attributes for the specified tape device, which include the device category, functions supported, usage and tape library configuration information. To access the Work with Tape Device panel, use the Work with Tape Device ([WRKTAPDEV](#)) command.

Adding Device Definitions

Using **Option 1** from the Work with Tape Device panel prompts the Add Tape Device ([ADDTAPDEV](#)) command, which defines tape device attributes.

```

Work with Tape Device
Position to . . . . . Starting chara
Type options, press Enter.
  1=Add 2=Change 4=Delete 5=Work with 8=
Opt  Device      Type  Description
  -  TAP01
  -  TAPMLB01    3494  IBM 3494 Tape Lib
  -  TAP04       3590  IBM 3590
  -  TAP05       3590  IBM 3590

Selection or command
====>

F3=Exit  F4=Prompt  F5=Refresh  F6=Auto
F11=View 2  F12=Cancel  F15=Status

Add Tape Device (ADDTAPDEV)
Type choices, press Enter.
Device name . . . . . > TAP01      Name, *DFT
Share device . . . . . *NO        *NO, *YES
Function supported . . *ALL      *READ, *WRITE, *ALL
Usage . . . . . *ANY          *ANY, *NEXT
Tape library information:
Library type . . . . . *NONE      *NONE, *IBM, *MTX, *STKDA...
Library device . . . . *NONE      Name, *NONE
Destination . . . . . *DEV        Name, *CAS, *CNV, *DEV...
Category:
Category name . . . . *SHARE400  *NOSHARE, *SHARE400,...
Category system . . . *CURRENT   *CURRENT,...
Text 'description' . . *DEV
    
```

Changing Device Definitions

To change a Device Definition, use **Option 2** from the Work with Tape Device panel. This prompts the Change Tape Device ([CHGTAPDEV](#)) command, which changes the Device Definition.

Deleting Device Definitions

To delete a Device Definition, use **Option 4** from the Work with Tape Device panel. This executes the Delete Tape Device ([DLTTAPDEV](#)) command, which deletes a Device Definition.

Note: Deleting a Device Definition deletes all tape usage attributes associated with the device. It is important to remember that MMS/*tms* requires a Device Definition for any device from which tapes will be tracked and managed.

Auto-Configuring Devices

MMS/*tms* provides the ability to automatically configure all tape devices currently configured on the iSeries. This function eliminates the need to manually configure the tape devices and tape libraries.

To auto-configure the tape devices, press **F6** on the Work with Tape Device panel. A message is issued when the configuration is complete. Press **F5** to refresh the display and view the results.

Auto-configuration can be performed whenever new devices or automated tape libraries are added/changed.

Note: IBM and StorageTek (STK) automated tape libraries are automatically configured. Memorex/Telex (MTX) libraries need to have the library information added to the MMS/*tms* Device Definition.

Working with Tape Usage

Tape usage defines density specific attributes for a device. There is one tape usage attribute record for each density that exists in the Device Definition. These attributes include the initialization attributes, tape pool ranges and the action to take if an out of range tape is encountered. To view and optionally change the tape usage attributes, select **Option 8** from the Work with Tape Device panel or use the Work with Tape Usage ([WRKTAPUSG](#)) command to display the tape device whose usage attributes to view or change.

Changing Tape Usage Attributes

To change the tape usage attributes for a specific density, select **Option 2** from the Work with Tape Usage panel. This prompts the Change Tape Usage ([CHGTAPUSG](#)) command, which modifies the attributes.

If multiple densities are defined in the tape Device Definition, then each density can have its own unique tape usage attributes.

```

Work with Tape Usage
Device: TAP01
Type options, press Enter.
  2=Change  8=Volumes

-----Tape Pool-----
Opt Density  R/W  Beginning Ending Error
  2 *QIC120  R   *BEGIN  *END  *IGNOR
  - *QIC2GB  R/W  *BEGIN  *END  *IGNOR
  - *QIC525  R/W  *BEGIN  *END  *IGNOR

Selection or command
===>

F3=Exit  F4=Prompt  F9=Retrieve  F11=View
(c) Copyright LXI Corp. 1985, 2006

Change Tape Usage (CHGTAPUSG)
Type choices, press Enter.
Device name . . . . . TAP01      Name, *ANY
Tape Density . . . . . *QIC120   *DEVTYPE, *QIC120, 10000...
Initialize:
Format . . . . . 0NNNNN        Character value, *SAME
Number . . . . . 000000        Character value, *SAME
Allow format change. . *YES     *SAME, *NO, *YES
Range:
Beginning . . . . . *BEGIN      Character value, *SAME...
Ending . . . . . *END          Character value, *SAME, *END
Tape range error . . . *IGNORE   *SAME, *IGNORE, *REJECT
Owner . . . . . *ANY          Character value, *SAME...
+ for more values _____

Bottom
F3=Exit F4=Prompt F5=Refresh F12=Cancel F13=How to use this display
F24=More keys
    
```

Device Sharing Concepts

MMS/*tms* device sharing is achieved through device **allocation** and **de-allocation**. This provides a method of sharing tape devices with multiple systems or jobs. Device sharing allows a device to be allocated, used, and then de-allocated making it available for other jobs requiring a device. By using device sharing, a job will not wait unnecessarily or end abnormally because a device is not readily available.

The Allocation Process

MMS/*tms* tries to allocate the requested tape device to the job. If the allocation is successful, the device is allocated and the job continues. If the allocation fails, MMS/*tms* checks if the device is in a shared pool with other similar devices. If so, and an available device is found, it is varied on and allocated to the job. If no other devices are available, an inquiry message is issued to the requestor, who can then choose to retry the allocation or end the job. If an allocation occurs, it remains in effect until the job ends.

The De-allocation Process

De-allocating a device makes the device available to other jobs or systems. If an allocated device is not explicitly de-allocated, it is implicitly de-allocated when the job completes, either normally or abnormally. Devices can only be de-allocated by the job that allocated them.

If a job, which uses a device that was allocated, ends abnormally, the device may not be varied off. MMS/*tms* re-allocates the device to another job if the prior job ended. This ensures that devices, from jobs that ended abnormally, can be allocated to another job.

Implementing Device Sharing

Device sharing is accomplished when tape devices which read/write the same density are defined as **SHARE(*YES)** in the Device Definition. Use the Work with Tape Device ([WRKTAPDEV](#)) command to add or change a Device Definition.

Device sharing requires that devices not currently in use be varied off. Devices are varied on through the Allocate Tape Device ([ALCTAPDEV](#)) command and varied off through the De-allocate Tape Device ([DLCTAPDEV](#)) command. Devices must be varied off in order to be allocated to a job. MMS/*tms* handles all device allocation processes through the Enhanced Command Support. Additional information about Enhanced Command Support is available in [Chapter 12, Customizing MMS/*tms*](#).

Allocate/De-allocate Examples

```
ALCTAPDEV DEV(TAP01)
MMS//tms - Device TAP02 has been successfully allocated.
```

In this example, device **TAP01** was requested. Since **TAP01** was not available, MMS/*tms* found another device and returned the device name of **TAP02** in the completion message. Both **TAP01** and **TAP02** use the same density and are defined in the Device Definition with ***YES** specified for the **SHARE** parameter.

```
DLCTAPDEV DEV(TAP02)
MMS//tms - Device TAP02 has been successfully deallocated.
```

In this example, device **TAP02**, which was allocated in the prior example, is de-allocated. When de-allocating, specify the drive that was allocated to your job.

If these commands are used in batch, they must be embedded into the program requesting a tape drive.

Note: IBM tape libraries require **SHARE(*NO)** in the MMS/*tms* Device Definition.

Initialization Concepts

Media initialization is the process of formatting a tape. The type of formatting required is dictated by the device and the type of environment in which the tape will be used. If the tape is being used for save/restore purposes, it should be initialized with a standard label. Standard labels contain information about the tape volume, such as volume identifier, density, date created, expiration date, and save information that contains details on the objects written to tape. If the tape is being used by another platform, it might need to be initialized as a non-labeled tape. This type of tape has no label information; just data. Non-labeled tapes are not valid for OS/400 save/restore functions. Regardless of the type of device or environment, all tapes used on an iSeries must be initialized.

Media Initialization Requirements

Media initialization is **not** required if the volume is already initialized and the volume has a unique volume identifier.

If you have non-unique volume identifiers, the volumes need to be re-initialized when they expire.

The MMS/*tms* INZTAP Command

To ensure volume identifier and database integrity, the IBM Initialize Tape command has been enhanced. The MMS/*tms* command functions like the IBM version and can be used in existing programs. The following functionality has been added to the MMS/*tms* **INZTAP** command:

- Verify the volume status (active/scratch)
- Verify that the new volume-id is available for use
- Verify the volume-id matches the user-defined format
- Automatically generate the next sequential volume-id
- Automatically initialize up to 99 volumes with one execution
- Automatically mount and dismount volumes from tape libraries
- Provide warning when changing a volume from ***SL** to ***NL**

Note: MMS/*tms* will not check for the existence of duplicate volume identifiers if the MMS/*tms* **INZTAP** command is **not** used. This could cause database integrity errors by allowing duplicate volume identifiers.

The Initialize Process

The following chart details the volume identifier used when the MMS/*tms* Initialize Tape command is used. *InzTap* refers to the volume identifier specified in the INZTAP command; *Tape* refers to the internal volume identifier; MMS/*tms* refers to the value in the database; *Used* is the actual volume identifier used to initialize the tape. A value of ----- indicates that the volume identifier does not exist.

| InzTap | Tape | MMS/ tms | Used | Notes |
|--------|---------------|---------------|---------------|--|
| 001000 | ----- | ----- | 001000 | |
| 001000 | 123456 | ----- | 001000 | |
| 001000 | 123456 | 123456 | 123456 | Re-initialized to same number |
| 001000 | 123456 | 001000 | 001000 | |
| 001000 | 001000 | ----- | 001000 | |
| 001000 | 001000 | 001000 | 001000 | |
| 001000 | ----- | 001000 | ----- | Error – volume id already exists |
| *GEN | 001000 | ----- | 112233 | Volume id generated by MMS/ <i>tms</i> |
| *GEN | 001000 | 001000 | 001000 | Re-initialized to same number |

Initializing *NL Tapes

Non-labeled tapes (***NL**) can be initialized with the MMS/*tms* Initialize Tape command by specifying ***NONE** in the NEWVOL parameter. When a volume that exists in the MMS/*tms* database is re-initialized as a ***NL** volume, an informational message is issued to the user noting the change. The volume is deleted from the MMS/*tms* database and initialized as ***NL**. Initialized ***NL** volumes are **not** written to the MMS/*tms* database.

When a volume that was previously initialized as ***NL** is re-initialized as ***SL**, MMS/*tms* prompts the user for a volume identifier. If the volume identifier entered by the user is one that exists in the MMS/*tms* database as a ***NL** tape, MMS/*tms* will allow the volume identifier to be reused.

If a ***SL** tape is re-initialized to a ***NL** tape as part of a copy process, such as **CPYTOTAP**, the volume identifier that exists on the tape prior to re-initialization is used in the MMS/*tms* database.

MMS/*tms* INZTAP Examples

The following examples illustrate some of the initialization methods supported by the MMS/*tms* Initialize Tape command.

```
INZTAP DEV(TAP01) NEWVOL(001000) CHECK(*NO) ENDOPT(*UNLOAD)
```

In this example, MMS/*tms* first checks the tape on **TAP01** and verifies that the volume identifier does not already exist in the database. If it does, it is used instead of the one supplied in the command. If it does not exist, the volume identifier specified in the command is used.

```
INZTAP DEV(TAP01) NEWVOL(*GEN) CHECK(*NO) ENDOPT(*UNLOAD)
```

In this example, MMS/*tms* checks the tape on **TAP01** and verifies that the volume identifier does not already exist in the database. If it does, it is used instead of the one supplied in the command. If it does not exist, the volume identifier specified in the Tape Usage attributes is used.

```
INZTAP DEV(TAP01) NEWVOL(*NONE) CHECK(*NO) ENDOPT(*UNLOAD)
```

In this example, MMS/*tms* first checks the tape on **TAP01** and verifies that the volume identifier does not already exist in the database. If it does, it is deleted before the tape is initialized as a non-labeled tape.

```
INZTAP DEV(TAP01) NEWVOL(*CTGID) CHECK(*NO) ENDOPT(*UNLOAD)
```

In this example, MMS/*tms* initializes the tape with the volume identifier specified on the bar code of the external tape label. The cartridge-id (***CTGID**) parameter is only valid for tape libraries.

Monitoring Devices

The Work with Tape Status ([WRKTAPSTS](#)) command lists all active tape devices. This list is **automatically refreshed** based on a user-specified time limit. As tape devices become active, they are added to the list. Devices that are no longer in use are automatically removed from the list. If the device has a message pending, it is highlighted to help identify devices needing a response. Tape device messages can be viewed and responded to from this panel by using **Option 7**. As the device is used, the volume identifier as well as the sequence number and data-set name, is displayed.

```

Work with Tape Status (WRKTAPSTS)
Type choices, press Enter.
Device name . . . . . *ALL
Wait time . . . . . 5

F3=Exit F4=Prompt F5=Refresh F12=Cancel F13=
F24=More keys
    
```

```

Work with Tape Status
Type options, press Enter.
5=Work with Job 7=Messages

Opt Device Volume Seq. DSN/Label Command
- - - - -
7 TAP08 100382 28 GLDTALIB SAVLIB
- TAP09 100695 127 QUSRSYS SAVCHGOBJ

F3=Exit F9=Command line F12=Cancel
    
```

Bottom

Chapter 7

Retention Management

One of the challenges in tape management is determining how long to retain data before reusing it. This is usually determined by the corporate audit department and is based on the information written to tape. If a tape is reused too soon, vital information may be lost. If the IBM default retention is used, the tapes will never be reused and the number of tapes required will increase. Retention, if applied correctly, maximizes tape usage and retains critical company data until its use is no longer required. There are two types of retention common in tape management. One is retention by days and the other is retention by generations.

This chapter discusses:

- Retention processing
- How to create retention attributes
- How to establish job retention

Retention Management Overview

MMS/*tms* retention management manages the reusability of tape volumes. When a tape volume is mounted for an output (write) function, MMS/*tms* retrieves the user-defined retention attributes for the job, and applies them to all volumes created by the job. Retention attributes are defined in the **Job Label**.

The Job Label provides a method of controlling tape attributes without having to change existing programs. When a save is performed, MMS/*tms* searches for a Job Label. If one does not exist, the job name is used to search for a Job Label. If that does not exist, the default Job Label is used.

Retention Types

MMS/*tms* provides the following types of tape retention:

- Retention by days
- Retention by generation

Retention by Days

Retention by days associates an expiration date with the saved data. If the data is valid for 23 days, then it expires on the 24th day. If different types of data with different expiration dates exist on the same tape, the tape expires when all expiration dates have been satisfied.

Retention by Generations

Retention by generations associates a number with a tape volume. If five month-end backups are required at all times, generation retention ensures that they exist, regardless of the expiration date. In the following example, when the June month-end backup tape is created, the January backup tape will become available for reuse and the five current generations will be from February through June. Saving Job Labels with different generations onto the same tape is not allowed. When using retention by generation, only one Job Label must be used per tape.

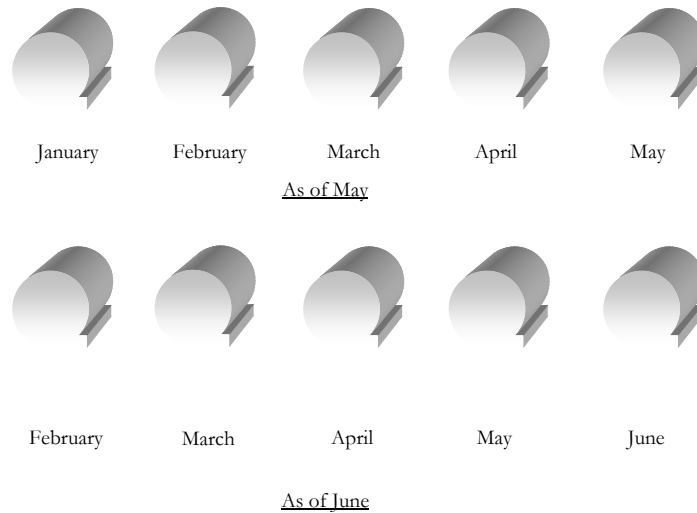

Retention by Generations/Days

When this type of retention is used, the volume is protected based on the generation requirements. When the generation requirements have been met, the expiration date takes effect.

Working with Retention Attributes

Job Labels associate user-defined attributes to a tape job. These attributes define data retention, volume text, data retrieval levels, and tape pool requirements. To work with retention attributes, use the Work with Job Label ([WRKJOBLBL](#)) command.

Adding Retention Attributes

Using **Option 1** from the Work with Job Label panel, enter a Job Label name. This prompts the Add Job Label ([ADDJOBLBL](#)) command, which defines retention attributes.

```
Work with Job Label
Position to . . . . . Starting ch
Type options, press Enter.
  1=Add  2=Change  3=Move Job  4=Delete  5=Work
  8=Saved Objects 9=Reference

Opt Job Label -----Text-----
  1 DAILY
  - *DFT      Default Job Label

Selection or command
====>

F3=Exit  F4=Prompt  F9=Retrieve  F11=View
F15=Retrieval level

Add Job Label (ADDJOBLBL)
Type choices, press Enter.
Job label . . . . . DAILY      Name, *DFT
Data retention:
Generations . . . . . 0        0-9999
Days . . . . . 30           0-9000, *PERM
Type of information to retain:
Document library object. . *BASIC *BASIC, *ALL
Lotus Notes/Domino . . . *BADIC *BASIC, *ALL
Integrated file system . . *BASIC *BASIC, *ALL
Libraries and objects. . . *LIB  *LIB, *OBJ, *MBR, *USRDFN
Save files . . . . . *BASIC *BASIC, *ALL, *USRDFN
Referenced tape pool. . . *NONE
System . . . . .           Name, *CURRENT
Print volume label. . . . *NO  *NO, *YES
Text 'description'. . . . Daily Backup

Bottom
F3=Exit  F4=Prompt  F5=Refresh  F10=Additional parameters  F12=Cancel
F13=How to use this display  F24=More keys
```

Changing Retention Attributes

The retention attributes of a Job Label can be changed as required. The changes are applied to the next tape function that uses the Job Label. To change a Job Labels' retention attributes, use **Option 2** from the Work with Job Label panel. This prompts the Change Job Label ([CHGJOBLBL](#)) command, which changes the retention attributes.

Deleting Retention Attributes

Deleting retention attributes is accomplished by deleting the Job Label to which they apply. To delete a Job Label, use **Option 4** from the Work with Job Label panel. This executes the Delete Job Label ([DLTJOBLBL](#)) command, which deletes the Job Label and tape usage attributes.

Note: When a Job Label which used generation retention is deleted, all volumes created with the Job Label are no longer protected by generations and the volumes expiration date is used to determine the status of the volume.

Generation Considerations

The following precautions and recommendations should be observed when using retention by generations.

- Generations are automatically recalculated when a:
 - Job Label is changed or deleted
 - Volume is added, changed to another Job Label, deleted, initialized, or reused.
- Performing multiple saves with different generations onto the same tape is not allowed. MMS/*tms* unloads the current tape and mounts a scratch tape when trying to append generations to the same tape. If appending data, use retention by days.
- If retention by generation is used, a minimum of 1 day should also be specified. This protects the tape in multiple system environments if the MMS/*tms* network is down or one or more systems are in restricted state.

Retention Requirements

A Job Labels' retention attributes determine the expiration date of the data that was written to tape. MMS/*tms* requires that the expiration date parameter of the IBM save/copy commands specify ***PERM**. If a date has been entered for the expiration date on an IBM save/copy command, the date entered is used instead of the date calculated by the Job Label. If a tape volume is being created from a high-level program, ensure that ***PERM** is specified in the expiration date parameter of the Override with Tape File (**OVRTAPF**) command.

The default expiration date on IBM supplied tape files is typically ***NONE**. If this value is used, the tape volumes created will be scratch tapes with an expiration date of **01/01/00**. To avoid this, perform one of the following:

- Override the expiration date to ***PERM** with the Override with Tape File (**OVRTAPF**) command;
- Change the IBM expiration date default with the Change Tape File (**CHGTAPF**) command;
- Create/use a user-created tape file that specifies ***PERM** as the expiration date.

Establishing Job Retention

Before a Job Label is used, it must be associated with an OS/400 job. Any valid OS/400 job can be associated with a Job Label. This association is accomplished by specifying a Job Label name in the:

- MMS/*tms* Cycle Volume ([CYCLE](#)) command
- IBM Submit Job (**SBMJOB**) command

The Cycle Volume Command

The Cycle Volume ([CYCLE](#)) command associates a Job Label with a tape job. The command can be used interactively or in batch. It can also be used from within a user program to add or change the Job Label associated to the job.

The command defaults to the default Job Label. Enter the Job Label that is associated with the tape job that uses this command. If a retention other than the default of ***PERM** is specified, it is overridden by the Job Label, if specified. The volume text parameter defaults to the value specified in the Job Label. This can be overridden by entering the text to be associated with the volumes created by the job.

Cycle Volume Example

The following examples illustrate some typical uses of the Cycle Volume ([CYCLE](#)) command. The first example shows how the command can be used interactively; the second uses multiple Job Labels from within a program.

| Work with Job Labels | | | |
|--|--------------|---------------------|--------|
| Position to . . . | | Starting characters | |
| Type options, press Enter. | | | |
| 1=Add 2=Change 3=Move Job 4=Delete 5=Work with 7=Archive Job | | | |
| 8=Saved Objects 9=Reference | | | |
| Opt | Job Label | ---Retention--- | Volume |
| | | Generations | Days |
| - | *DFT | 0 | 90 |
| - | DAILY | 0 | 30 |
| | | | Label |
| | | | *NO |
| | | | *NO |
| Selection or command | | | Bottom |
| ==> | | | |
| F3=Exit F4=Prompt F9=Retrieve F10=View 1 F11=View 3 F12=Cancel | | | |
| F15=Retrieval level | | | |

```
CYCLE CYCLE(*JOBLBL) LABEL(DAILY)
SAVLIB LIB(*ALLUSR) DEV(TAP01) SEQNBR(1) EXPDATE(*PERM) +
  ENDOPT(*UNLOAD)
```

In this example, the Job Label **DAILY** is associated with the job. *MMS/tms* calculates the expiration date for all volumes created by this job.

```
PGM
CYCLE CYCLE(*JOBLBL) LABEL(DAILY)
SAVLIB LIB(APLIB) DEV(TAP01) SEQNBR(1) EXPDATE(*PERM) +
  ENDOPT(*UNLOAD)

CYCLE CYCLE(*JOBLBL) LABEL(*DFT)
SAVLIB LIB(ARLIB) DEV(TAP01) SEQNBR(1) EXPDATE(*PERM) +
  ENDOPT(*UNLOAD)

CYCLE CYCLE(7)
SAVLIB LIB(GLLIB) DEV(TAP01) SEQNBR(1) EXPDATE(*PERM) +
  ENDOPT(*UNLOAD)
ENDPGM
```

This performs three saves; two of them using different Job Labels. The expiration date on the tapes created by the first two saves is based on the retention attributes specified in the Job Labels being referenced. The third save does not use a Job Label. The expiration date and text for volumes created by this job is specified in the command. The retention requirements for the first two saves can be changed interactively through the Work with Job Label panel. The program would require modifications if the retention attributes for the third save changed.

The Submit Job Command

The **JOB** parameter of the IBM Submit Job (**SBMJOB**) command can be used to associate a Job Label with a tape job. This allows a tape function to be associated with a Job Label without having to use the Cycle Volume command.

```
Work with Job Label
Position to . . . Starting characters
Type options, press Enter.
 1=Add 2=Change 3=Move Job 4=Delete 5=Work with 7=Archive Job
 8=Saved Objects 9=Reference

Opt Job Label      ---Retention--- Volume
                  Generations Days  Label
- *DFT              0          90   *NO
- DAILY            0          30   *NO

Selection or command                                Bottom
====>

F3=Exit F4=Prompt F9=Retrieve F10=View 1 F11=View 3 F12=Cancel
F15=Retrieval level
```

Submit Job Example

The following example illustrates the use of the Submit job command.

```
SBMJOB CMD(SAVLIB LIB(*ALLUSR) DEV(TAP01) SEQNBR(1) +
          ENDOPT(*UNLOAD)) JOB(DAILY)
```

This submits a save function using the job name **DAILY**. MMS/*tms* uses the default Job Label if a job name that does not have an associated Job Label is specified.

Retention Hierarchy

The following diagram shows the path MMS/*tms* uses in determining which tape retention attributes to use. The attributes can be defined in the Cycle Volume command or they can be the name of an iSeries job.

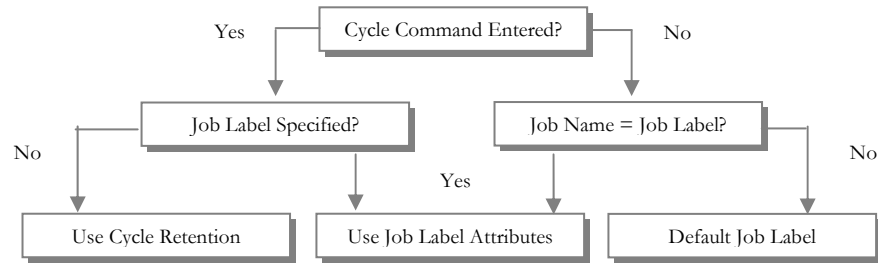

Chapter 8

Using Tape Pools

Tape pools are used when a job requires the use of tapes within a specific range, or when a device will only process a specific type or density of tape. Tape pools ensure that the correct tape is mounted and used. Tapes that are not within the user-specified range, can be rejected or ignored.

Tape pools can be used in tape libraries. If used, they help MMS/*tms* identify the tapes that the library uses. Since multiple tape libraries as well as multiple stand-alone devices are supported for one or more systems on the same network, tape pools ensure that MMS/*tms* knows which tape volumes are available for any defined device.

Tape pools from remote systems in the MMS/*tms* network can be referenced on the local system. This simplifies the ability to save multiple systems to the same tape.

This chapter discusses:

- Tape pool processing
- Tape pool mounting options
- How to create a tape pool

Tape Pool Overview

MMS/*tms* tape pool management ensures that the right tapes are used for any job that requires specific volumes. Tape pools are defined in the **Job Label**. When a tape volume is mounted, MMS/*tms* retrieves the pool definition to determine if tape pool support is required. If it is, the volume mounted on the tape device is verified against the Job Label pool requirements to ensure that it is within the specified range. If it is, the job continues. If a tape range error occurs, MMS/*tms* either rejects the volume in favor of another one or ignores the discrepancy and uses the volume. If the volume requested through tape pool support is not mounted, a message is issued to the System Operator. If the device is in a tape library, MMS/*tms* mounts the required volume identifier based on the mounting options.

Working with Tape Pool Attributes

Tape pool attributes are divided into two sections. The first section defines the range of volumes that can be used. This includes the beginning and ending range as well as the action to take for a volume that is outside the specified range. The second defines how volumes are requested and/or mounted. If tape libraries are used, the mounting options determine how volumes are mounted. To work with tape pool attributes, use the Work with Job Label ([WRKJOBLBL](#)) command.

Mounting Options

MMS/*tms* mounting options are defined in a Job Labels' pool definition and are used to determine which volume identifier to mount.

| Mounting Option | Stand-alone Tape Device | Tape Library |
|-----------------|---|--|
| *ANY | Accepts any mounted volume. If a volume is not mounted the standard OS/400 "Device &1 not ready..." message is issued to the QSYSOPR message queue. | <p>IBM - Refer to *NEXT.</p> <p>MTX - Allows tape library server to select volume.</p> <p>STK Direct Attach - Refer to *NEXT.</p> <p>STK Server Attach - Allows tape library server to select volume.</p> <p>STK Library Station - Allows tape library server to select volume.</p> |
| *NEXT | The next available volume identifier found in the MMS/ <i>tms</i> database is requested. The volume expiration date, density, security and location are verified before the volume is used. | The next available volume identifier found in the MMS/ <i>tms</i> database is mounted. The volume expiration date, density, security and location are verified before the volume is mounted. |
| *LAST | Requests the last volume identifier used by the Job Label. | The last volume used by the Job Label is mounted. If the last volume does not exist, the next available scratch volume is mounted. If a continuation volume is required, an available scratch volume is found and mounted. |

Note: A tape library **must** be defined as a random access device if automated tape mounting is required.

Adding Job Pools

Using **Option 1** from the Work with Job Label panel, enter a Job Label name. This prompts the Add Job Label ([ADDJOBLBL](#)) command, which defines retention attributes. The tape pool attributes are displayed if the Job Label does not reference another Job Label.

Changing Job Pools

Using **Option 2** from the Work with Job Label panel, select the Job Label whose tape pool attributes to change. This prompts the Change Job Label ([CHGJOBLBL](#)) command, which defines tape pools.

Job Pool Example

In the following example, Job Label **DAILY** is setup to use a tape pool range from **800000** to **800999**. Specifying ***AVAIL** for the Last used parameter indicates that MMS/*tms* will find the first available volume. The value ***NEXT** in the Usage parameter specifies that MMS/*tms* will prompt for the volume if one is not loaded and the value ***REJECT** in the Volume range error parameter specifies that the volume will be rejected and unloaded if it does not fall within the tape pool range.

The image shows a terminal window with three overlapping panels. The top-left panel is titled "Work with Job Label" and shows options for adding, changing, moving, deleting, or saving job labels. The top-right panel is titled "Change Job Label (CHGJOBLBL)" and shows the configuration for the "DAILY" job label, including data retention (0 generations, 30 days) and information to retain (BASIC). The bottom panel is also titled "Change Job Label (CHGJOBLBL)" and shows the configuration for the "DAILY" job label's tape pool, including the range (800000-800999), last used (*AVAIL), usage (*NEXT), and tape range error (*REJECT). The bottom panel also shows function key definitions: F3=Exit, F4=Prompt, F5=Refresh, F12=Cancel, F13=How to use this display, F24=More keys.

```
Work with Job Label
Position to . . . . . Starting ch
Type options, press Enter.
1=Add 2=Change 3=Move Job 4=Delete 5=Work
8=Saved Objects 9=Reference

Opt Job Label -----Text-----
1 DAILY
- *DFT Default Job Label

Selection or command
===>
F3=Exit F4=Prompt
F15=Retrieval level

Change Job Label (CHGJOBLBL)
Type choices, press Enter.
Job label . . . . . DAILY Name, *DFT
Data retention:
Generations . . . . . 0 0-9999
Days . . . . . 30 0-9000, *PERM
Type of information to retain:
Document library object . . *BASIC *BASIC, *ALL
Lotus Notes/Domino . . . . *BASIC *BASIC, *ALL

Change Job Label (CHGJOBLBL)
Type choices, press Enter.
Tape Pool:
Beginning . . . . . 800000 Character value, *SAME, *DEV
Ending . . . . . 800999 Character value, *SAME, *DEV
Last used . . . . . *AVAIL Character value, *SAME...
Usage . . . . . *NEXT *SAME, *DEV, *ANY, *NEXT...
Tape range error . . . . . *REJECT *SAME, *DEV, *IGNORE...

Bottom
F3=Exit F4=Prompt F5=Refresh F12=Cancel F13=How to use this display
F24=More keys
```

Adding Device/Density Pools

Tape pools can be created at the device/density level instead of the Job Label level. If all jobs using a specific device/density use the same tape range, the tape pool can be set up at the device/density level. This eliminates the need to specify the tape device pool attributes for each Job Label.

Device pools are automatically created when a Device Definition is created. Use **Option 8** from the Work with Tape Device ([WRKTAPDEV](#)) panel or use the Work with Tape Usage ([WRKTAPUSG](#)) command to display or optionally change the tape device pool attributes.

Changing Device Pools

To change the attributes of a specific device pool, use **Option 2** from the Work with Tape Usage panel. This prompts the Change Tape Usage ([CHGTAPUSG](#)) command where the volume range for the device can be specified. If multiple densities exist in the tape Device Definition, then each density can have its own unique volume range.

Device Pool Example

In the following example, a volume range from **000000** to **000100** has been established for device **TAP10**, density ***QIC120**. The value ***REJECT** has been specified for the Volume range error parameter to ensure that any volume that does not match the range is rejected and unloaded by the device.

Specify ***DEV** on the Job Label tape pool attributes for any parameter(s) specified at the device level.

The screenshot shows three overlapping terminal windows from the MMS/TMS system:

- Work with Tape Device (WRKTAPDEV):** Shows a list of device definitions. Option 8 is selected for device TAP01, which is a QIC Drive.
- Work with Tape Usage (WRKTAPUSG):** Shows the selection of Option 2 (Change) for device TAP01. It lists available densities: *QIC120, *QIC2GB, and *QIC525.
- Change Tape Usage (CHGTAPUSG):** Shows the configuration for device TAP01 and density *QIC120. Key parameters are:
 - Device name: TAP01
 - Tape Density: *QIC120
 - Initialize: Format (0NNNNN), Number (000000), Allow format change (*YES)
 - Tape pool: Beginning (000000), Ending (000100), Tape range error (*REJECT), Owner (*ANY)

Chapter 9

Volume Management

Changes are the only constant in a data center and when tape requirements change, MMS/*tms* provides the flexibility to implement the changes quickly and efficiently. Changes are easily implemented through Work with... panels or through commands. MMS/*tms* auditing ensures that all changes are logged to the system history log for review. Network management ensures that changes are reflected on all remote (target) systems participating in the network.

This chapter discusses:

- Volume management processing
- Volume management commands
- Volume management command requirements

Volume Management Overview

MMS/*tms* volume management provides the flexibility to successfully manage tape volumes. The Work with Volume panel is designed to provide a central point of control for volume management. The management options can be performed directly from the panel or the respective command can be entered from a command line. When a volume management command is entered, the specified volume is checked to ensure that the requested function can be performed. If the change is allowed, the function is performed. If a function cannot be performed due to an invalid request or security issue, an error message is sent to the requestor. If the function completes successfully, a completion message is sent. All changes are written to the system history log.

Volume Management Commands

Volume management commands are used to add, change, delete or work with volume attributes. Most volume commands can be accessed through the Work with Volume panel. Use the Work with Volume ([WRKVOL](#)) command to access this panel.

The functions/commands supported include:

- Adding a volume ([ADDVOL](#))
- Changing a volume ([CHGVOL](#))
- Clearing a volume ([CLRVOL](#))
- Deleting a volume ([DLTVOL](#))
- Displaying volume information ([DSPVOLINF](#))
- Displaying volume contents ([DSPVOLDTA](#))
- Duplicating a volume ([DUPVOL](#))
- Retrieving a volume ([RTVVOL](#))
- Displaying volume history ([SCNLOG](#))
- Securing a volume ([CHGVOLSEC](#))

Adding a Volume

The Add Volume ([ADDVOL](#)) command manually adds one or more volume identifiers and optional volume contents to the database. This function provides the ability to add volumes from other sources/platforms. If multiple systems reside in the MMS/*tms* network, the volumes are added on all remote (target) systems.

Volumes added through this command can be associated with a Job Label. If the Job Label uses retention by generations, the generations for all volumes using this Job Label are recalculated.

If multiple volumes are entered into the **ADDVOL** command, they are treated like a multi-volume save. All volumes entered are verified against the database. A volume, which exists in the database, cannot be re-added unless the status of the volume is expired. When an expired volume is updated, the volume description and contents are replaced.

If **CONTENTS(*YES)** is specified, a data entry panel is presented to allow the entry of volume contents. Volume contents are verified to ensure that they follow tape-processing methodologies.

Changing Volume Attributes

The Change Volume ([CHGVOL](#)) command changes specific attributes of a volume. If the volume is part of a multi-volume save, only the first volume must be specified. MMS/*tms* updates all associated volumes with the changes.

Changing the Job Label

Changing the Job Label of a volume removes the volume from the current Job Label and associates it with the new Job Label. If the current Job Label uses retention by generations, the volume is removed from the generation count and the current Job Label recalculates its generations. If the new Job Label uses retention by generations, the new Job Label generations are recalculated based on the volumes being added.

Changing the Job Label does **not** effect the expiration date of the volume unless ***JOBLBL** is specified in the **EXPDAT** parameter. If specified, the volume expiration date must be greater than or equal to the current expiration date of the volume.

Changing the Expiration Date

Changing the expiration date of the volume causes the status of the volume(s) to be based on the new expiration date. If the volume is part of a generation, the expiration date has no effect until the generation requirements have been met.

If ***JOBLBL** is specified for this parameter, the volumes expiration date is recalculated based on the Job Label.

The expiration date of a volume **cannot** be changed to a lesser value.

Changing the Text

Changing the text changes the volume text of the specified volume and all associated volumes. If a Job Label is specified and ***JOBLBL** is entered for the **TEXT** parameter, the volume text is the same as the Job Label.

Clearing a Volume

The Clear Volume ([CLRVOL](#)) command removes the contents from the MMS/*tms* database. The volume information is not changed. If volume contents reside on another system, the contents are not cleared.

Deleting a Volume

The Delete Volume ([DLTVOL](#)) command removes the volume information and contents from the MMS/*tms* database. If volume contents reside on another system, they are deleted.

Displaying Volume Information

Volume information can be viewed by using **Option 5** from the Work with Volume panel or by using the Display Volume Information ([DSPVOLUME](#)) command. Basic volume information can also be viewed by pressing the **F11** key on the Work with Volume panel.

Displaying Volume Contents

The volume contents can be viewed by using **Option 8** from the Work with Volume panel or by using the Display Volume Data ([DSPVOLDTA](#)) command. The amount of information shown is based on the MMS/*tms* customization options selected. Refer to [Chapter 12, Customizing MMS/*tms*](#), for details on these options.

If the volume was created on another system in the MMS/*tms* network, a temporary communication link to the system is created and used to list the data.

```

Work with Volume
-----
Position to . . . . . Volume ident
Type options, press Enter.
1=Add 2=Change 3=Move 4=Delete 5=
8=Data 9=Security 13=History
Opt Volume Date Time Status -----
8 800015 08/09/04 11:19:27 *ACT LXI W
- 800014 08/02/04 16:49:13 *ACT LXI W
- 800011 07/26/04 14:54:43 *ACT LXI W
- 800004 07/18/04 22:03:20 *ACT LXI W
- STK143 07/16/04 11:11:07 *SCR STK 9
- STK142 07/15/04 18:07:30 *SCR STK 9
- 800021 07/11/04
-----
Selection or command
====>
F3=Exit F4=Prompt

Display Volume Data
-----
Volume . . . . : 700001 Position to . . . .
Type options, press Enter.
3=Next level
-----Save-----
Opt Sequence File Label Date Time Command System
- 1 ACCTFIL 05/03/05 20:35:14 SAVLIB S1234567
- 2 ACCTPGM 05/03/05 20:35:55 SAVLIB S1234567
- 3 DEVFILLIB 05/03/05 20:38:27 SAVLIB S1234567
- 4 DEVPGMLIB 05/03/05 20:41:27 SAVLIB S1234567
- 5 GLFILLIB 05/03/05 20:43:49 SAVLIB S1234567
- 6 GLPGMLIB 05/04/05 20:45:12 SAVLIB S1234567
- SAVLIB S1234567 SAVLIB S1234567
-----
Display Volume Data
-----
Library . . . . : DEVPGMLIB System . . . . : S1234567
ASP . . . . . : 1 Release . . . . : V5R2M0
Volume . . . . : 700001 Sequence . . . . : 4
Expires . . . . : 08/14/06 Data compressed: No
Command . . . . : SAVLIB Data compacted : Yes
Format . . . . : Serial
Save date/time : 05/03/05 20:41:27
-----
Type options, press Enter.
3=Next level
-----
Opt Object Type Attribute Member Size
- QCLSRC *FILE PF CLMBR001 45056
- QCLSRC *FILE PF CLMBR002 45056
- QCLSRC *FILE PF CLMBR003 45056
- QCLSRC *FILE PF CLMBR004 45056
-----
Selection or command
====>
F3=Exit F4=Prompt F9=Retrieve F11=View 2 F12=Cancel F17=Top
F18=Bottom
    
```

Displaying Volume History

The volume history can be viewed by using **Option 13** from the Work with Volume panel. The volume history lists any action that occurred to a volume including initializes, saves, restores, changes, moves, returns and deletes. This option uses the MMS/*tms* Scan Log ([SCNLOG](#)) command and requires that the IBM History Log entries exist for the save date/time of the specified volume.

Refer to [Chapter 12](#), *Auditing MMS/tms*, for more information on the Scan Log ([SCNLOG](#)) command.

Duplicating a Volume

The Duplicate Volume ([DUPVOL](#)) command provides a simple method of duplicating tapes. Tapes can be duplicated based on a volume identifier or a specific Job Label. If a volume identifier is specified and the sequence number specified on the **FROMSEQNBR** parameter starts on a subsequent volume, MMS/*tms* automatically selects the correct volume and starts the duplication from there. If a Job Label is specified, only the volume(s) associated with the last save of a Job Label are duplicated. The following should be noted if volume(s) are duplicated to the Job Label that created them.

- The last “To” volume will replace the last “From” volume as the Last used volume in the Job Label. This feature allows one or more Job Labels to be appended to the same volume. Periodically, the volume can be duplicated specifying **FILES(*ACTIVE)**. The new volume will contain only active files and will be used when requested by the Job Label.
- If the “From” volume(s) were saved using retention by generations, the “To” volume will become the current generation.

Retrieving a Volume

The Retrieve Volume ([RTVVOL](#)) command retrieves and catalogs volume information into the MMS/*tms* database. This command reads the tape volume and records the volume and volume content information into the database. Volume contents can be added at library or object level.

This command does not support non-labeled tapes or any volume sequence used for saving either Document Library Objects (DLO) or Integrated File System objects (IFS). Use the Add Volume ([ADDVOL](#)) command to add these types of volumes into the database.

Volume Security

Use **Option 9** from the Work with Volume panel or the Change Volume Security ([CHGVOLSEC](#)) command to change the save/restore security assigned to a volume. Volume security is volume based. If a volume is secured, no one, regardless of OS/400 authority, can override it. This ensures that the volume is protected. Additionally, a secured volume cannot be changed, cleared, deleted or scratched.

Note: It is recommended that ***PUBLIC** authority for the this command be removed and that authority be granted only to authorized personnel.

Chapter 10

The MMS/tms Network

Today's Data Centers seldom function on a single system. Even the smaller environments have several systems. Some systems are used for production; others for development and testing; still others are used for specific applications. Regardless of the configuration, these systems are usually backed up using a single tape pool because it is cost effective and easier to manage. To implement this process requires that communication between systems is fast and accurate. To ensure that a tape created on one system is not used on another requires that the creating system notify all remotes in the network as soon as possible. Systems, which may be slower than others or disabled, should not have an effect on the communication to other systems in the network. A communication process must be able to handle these conditions independently.

This chapter discusses:

- Communication processing
- How to create a communication link
- Communication link options

Communication Overview

MMS/*tms* uses a **communication link definition** to define a remote location. When a tape volume is used, MMS/*tms* notifies all remote systems defined in the MMS/*tms* network, and updates them with the volume information as required. If a remote system is disabled, the communication transactions are queued until the disabled system becomes operational. Communication transactions are created for every change to a volume, which includes save date/time, expiration date, status, text, location, security, and Job Label.

To ensure that all systems are updated as quickly as possible, every remote system defined to MMS/*tms* has its own communication program. This prevents a slower system from slowing down communications with other faster systems in the network. All communications are sent from the QLXI subsystem.

Communication Types

MMS/*tms* supports the following types of communication.

- CPIC (OS/400)
- TCP/IP (OS/400, AIX, UNIX)

Determining Which to Use

MMS/*tms* can use CPIC or TCP/IP to communicate with other MMS/*tms* systems in the network. CPIC is the default. If communication is with other OS/400 systems, both CPIC and TCP/IP parameters can be defined on the same communication definition. This provides the ability to instantly change the method of communication, if needed.

If MMS/*tms* is communicating with an AIX, UNIX or Windows system, TCP/IP *must* be used. If the Platform (**PLATFORM**) parameter is incorrectly defined, unpredictable results will occur, which will cause corrupted data to be sent through the network.

Communication Differences

The following chart lists the processing differences between using CPIC and TCP/IP in the MMS/*tms* environment.

| CPIC | TCP/IP |
|---|---|
| Source program runs in subsystem QLXI. Target program runs in subsystem QCMN. | Source program runs in subsystem QLXI. Target program runs in subsystem QLXI. |
| User profile LXI required. | No user profile required. |

Working with Communication Links

The Work with Communication Links ([WRKCMNLNK](#)) command lists all or specific communication links.

Adding a Communication Link

Using **Option 1** from the Work with Communication Links panel, type a remote location name and press **Enter**. This prompts the Add Communication Link ([ADDCMNLNK](#)) command, which defines the remote location.

MMS/*tms* tests the communication link prior to adding it. If communication between the local (**source**) and remote (**target**) systems cannot be established, the link is not added.

The type of communication that is used is determined by the Link Type (**LNKTYPE**) parameter. The default is ***CPIC**. If TCP/IP is used, the value must be changed to ***TCP**. If communicating with a UNIX system, the Platform (**PLATFORM**) parameter must specify the correct value.

```
Work with Communication Links
-----
Position to . . . . .
Type options, press Enter.
  1=Add    2=Change 4=Delete 5=Display
 10=End   13=Pending

Opt Remote  Link      Status  Opt Ret
 1  S1122334

Selection or command
====>

F3=Exit F4=Prompt F5=Refresh F9=Retrieve
F15=Display Messages

Add Communication Link (ADDCMNLNK)
-----
Type choices, press Enter.
Remote location . . . . . S1122334      Name
System name . . . . . *RMTLOCNAME      Name, *RMTLOCNAME
Link type . . . . . *CPIC              *CPIC, *TCP
Device description . . . . . *LOC       Name, *LOC
Local location name . . . . . *LOC       Name, *LOC, *NETATR
Mode . . . . . *NETATR                 Name, *NETATR
Remote network identifier . . . *LOC     Name, *LOC, *NETATR
Transaction program . . . . . 'LXITMS/TM$CPIIR'
Platform . . . . . *OS400              *OS400, AIX, *UNIX
Internet address . . . . . *TCPHTE
Remote port number . . . . . *PRDOPT    1-65535 *PRODOPT
Local internet address . . . . *PRDOPT

Bottom
F3=Exit F4=Prompt F5=Refresh F12=Cancel F13=How to use this display
F24=More keys
```

Changing a Communication Link

To change a communication links attributes, use **Option 2** from the Work with Communication Links panel. This prompts the Change Communication Link ([CHGCMNLNK](#)) command, which changes the remote location definition.

MMS/*tms* tests the communication link prior to changing it. If communication between the local (**source**) and remote (**target**) systems cannot be established, the changes are ignored.

Deleting a Communication Link

To delete a communication link definition, use **Option 4** from the Work with Communication Links panel. This executes the Delete Communication Link ([DLTCMNLNK](#)) command, which deletes a remote location definition.

Deleting a communication link:

- removes the communication link definition from MMS/*tms*
- deletes pending communication transactions
- ends the MMS/*tms* remote communication job
- deletes the remote communication job definition

Testing a Communication Link

Once a communication link has been defined, it can be tested as needed. Use **Option 6** from the Work with Communication Links panel or the Test Communication Link ([TSTCMNLNK](#)) command to test a link. An escape message is issued if a test to a remote location fails to respond.

Comparing Remote Databases

It is possible for a local database to get out of sync with a remote database. Power outages, device failures, program failures and abnormal terminations are some of the possible reasons that synchronization problems occur. MMS/*tms* provides several checks that ensure that all updates occur, however if a problem should occur, the local and remote databases can be synchronized.

Use **Option 7** from the Work with Communication Links panel or the Compare Volume ([CMPVOL](#)) command to compare the volumes on the local (**source**) system with those on the remote (**target**) system and list all discrepancies. Options allow the local system to update the remote system if the local volume information is more current than the remote. If a discrepancy is found and the local information is more current, a communication transaction is created which updates the remote system.

This command should *not* be run if there is any:

- tape activity
- communications pending to any remote system
- CMPVOL running on another system

Starting a Communication Link

If a previously ended or a newly created communication link needs to be started without ending and restarting the QLXI subsystem, use the Start Communication Link ([STRCMNLNK](#)) command. Starting a communications link causes all pending communication transactions to be sent to the remote (**target**) system. Starting a remote link optionally starts the link from the remote system to the local system.

Ending a Communication Link

If an active communication link needs to be stopped without affecting other active communication links, use the End Communication Link ([ENDCMNLNK](#)) command. Any pending communication transactions for the remote (**target**) system are held until communications is reestablished. When the link is restarted, communications will continue. Ending a remote link optionally ends the link from the remote system to the local system.

Viewing Communication Transactions

As volumes are used, MMS/*tms* writes communication transaction records to a database. These records are removed from the database when the information has been successfully updated on the remote system. To view pending communication transactions for a specific system, use **Option 13** from the Work with Communication Links panel. This panel is **automatically refreshed** every 5 seconds.

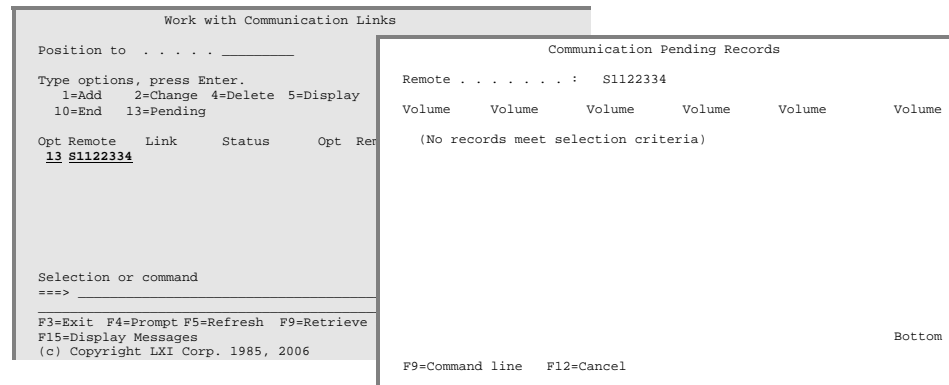

CPIC Requirements

CPIC uses a transaction program to communicate with the remote system. The name of the transaction program used is specified in the MMS/*tms* communication commands and should not be changed.

The Communication Profile

CPIC requires a user profile and password on the source and target systems. When MMS/*tms* is installed, a user profile named LXI is created. This profile is created with the lowest authority available and the initial menu and initial program are such that it only functions for MMS/*tms* communications.

Note: Do **not** change the password, disable or expire the LXI communications profile. Changing, disabling or expiring the profile stops CPIC communications to remote systems.

If the LXI profile does not exist, it can be created by entering the following:

```
CRTUSRPRF USRPRF(LXI) PASSWORD(LXI) USRCLS(*USER) + INLPGM(*NONE)
INLMENU(*SIGNOFF) SPCAUT(*NONE) TEXT('MMS/tms communications pro-
file')
```

TCP/IP Requirements

To add a TCP/IP communication link, the Internet address (**INTNETADR**) and Remote port number (**RMTPORT**) parameters *must* be specified. The Internet address (**INTNETADR**) parameter is the TCP/IP Internet address of the *remote location* being defined.

The Remote port number (**RMTPORT**) must match the Local port number (**LCLPORT**) value specified in the Product Options. Refer to [Chapter 12, Customizing MMS/tms](#), for details on specifying the Local port number.

The Local Internet address (**LCLINTNETA**) parameter is used if no TCP/IP Host Table entry for the specified Internet address is defined. If no entry exists, a Host Table entry is added. If an entry exists for the specified Internet address, the value specified in the Host name (**HOSTNAME**) parameter is ignored. The host name defined for the remote system in the Host Table on the local system is used as the job name for the remote system in the QLXI subsystem.

The following table shows how remote location job names are determined based on the values in the Host Table.

| Host Table Name | Job Name in SBS QLXI | Notes |
|-----------------|----------------------|--|
| SYSTEMA | SYSTEMA | Job Name equals Host Table Name |
| SYSTEMATEST | SYSTEMAT | Only first 8-characters are used. |
| SystemA | SYSTEMA | Converted to upper-case. |
| SysA.COM | SYSA | Converted to upper-case up to the period. |
| Sys-A.COM | SYS_A | '-' converted to '_' and ... converted to upper-case up to the period. |

The Communication Journal

MMS/*tms* tracks and manages volume changes through the OS/400 journal facility. The journal, its receiver and other associated objects are not created unless MMS/*tms* communications is used. When the first communication link is added, MMS/*tms* automatically creates a journal and journal receiver in library **LXITMS400**.

MMS/*tms* manages the changing of the journal receivers. When an attached journal receiver reaches the size threshold, it is automatically detached and a new journal receiver is generated and attached.

If no communication is performed by MMS/*tms* or if all communication definitions are deleted, the journal and all associated receivers are deleted.

The QLXI Subsystem

All MMS/*tms* communication functions are processed through the QLXI subsystem. These functions include communication recovery, communication transactions and interfaces to other platforms/products. This subsystem must remain active unless restricted state is required.

Starting the Subsystem

Starting the QLXI subsystem starts the communication links to remote (**target**) systems. To start the subsystem, enter the following:

```
STRSBS SBS(DLXI/QLXI)
```

Ending the Communication Subsystem

Ending the QLXI subsystem stops all communication transactions to the remote (**target**) systems. To end the subsystem, enter the following:

```
ENDSBS SBS(QLXI) OPTION(*IMMED)
```

Communication Examples

The following communication examples illustrate how to set up communications between:

- Two iSeries using CPIC
- Two iSeries using TCP/IP
- One iSeries and one UNIX using TCP/IP

Connecting the iSeries using CPIC

In this example, two iSeries are connected using **CPIC**. Example values for the Add Communication Link ([ADDCMNLNK](#)) command parameters are shown below. In addition to the communication link definition, the LXI user profile *must* exist, have a password of LXI and be enabled.

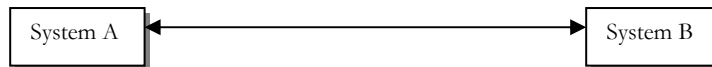

| | |
|------------|--------------------|
| RMTLOCNAME | SYSTEMB |
| SYSTEM | *RMTLOCNAME |
| LNKTYPE | *CPIC |
| DEV | *LOC |
| LCLOCNAME | *LOC |
| MODE | *NETATR |
| RMTNETID | *LOC |
| TNSPGM | 'LXITMS/TM\$CPI1R' |
| PLATFORM | *OS400 |

| | |
|------------|--------------------|
| RMTLOCNAME | SYSTEMA |
| SYSTEM | *RMTLOCNAME |
| LNKTYPE | *CPIC |
| DEV | *LOC |
| LCLOCNAME | *LOC |
| MODE | *NETATR |
| RMTNETID | *LOC |
| TNSPGM | 'LXITMS/TM\$CPI1R' |
| PLATFORM | *OS400 |

Connecting the iSeries using TCP/IP

In this example, two iSeries are connected using **TCP/IP**. Example values for the Add Communication Link ([ADDCMNLNK](#)) command parameters are shown below.

The Internet address (**INTNETADR**) specified on the **SYSTEM A** communication link definition is the Internet address of **SYSTEM B** and the Internet address specified on the **SYSTEM B** communication link definition is the Internet address of **SYSTEM A**.

The value specified in the Remote port parameter on **SYSTEM A** *must* match the value specified in the Local port (**LCLPORT**) parameter of the Change Product Option ([CHGPRDOPT](#)) command on **SYSTEM B**. The value specified in the Remote port parameter on **SYSTEM B** *must* match the value specified in the Local port (**LCLPORT**) parameter of the Change Product Option ([CHGPRDOPT](#)) command on **SYSTEM A**.

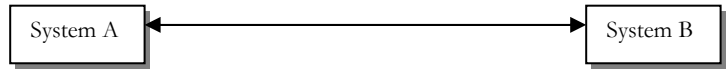

| | |
|------------|-----------------------|
| RMTLOCNAME | SYSTEMB |
| SYSTEM | *RMTLOCNAME |
| LNKTYPE | *TCP |
| PLATFORM | *OS400 |
| INTNETADR | nnn . nnn . nnn . nnn |
| RMTPORT | nnnnnnnnnn |
| LCLINTNETA | *PRDOPT |

| | |
|------------|-----------------------|
| RMTLOCNAME | SYSTEMA |
| SYSTEM | *RMTLOCNAME |
| LNKTYPE | *TCP |
| PLATFORM | *OS400 |
| INTNETADR | nnn . nnn . nnn . nnn |
| RMTPORT | nnnnnnnnnn |
| LCLINTNETA | *PRDOPT |

| | |
|---------|------------|
| PRDID | *TMS |
| LCLHOST | ----- |
| LCLPORT | nnnnnnnnnn |
| RMTPORT | ----- |

| | |
|---------|------------|
| PRDID | *TMS |
| LCLHOST | ----- |
| LCLPORT | nnnnnnnnnn |
| RMTPORT | ----- |

Connecting the iSeries with Unix using TCP/IP

In this example, a **UNIX** tape management system, such as LXI **TMS/ix** or **Tape Tracker**, is connected to an iSeries using **TCP/IP**. Example values for the Add Communication Link ([ADDCMNLNK](#)) command parameters are shown below.

The Internet address (**INTNETADR**) specified on the **SYSTEM A** communication link definition is the Internet address of **SYSTEM B**.

The value specified in the Remote port parameter on **SYSTEM A** *must* match the value that the **UNIX** system is using for communications to MMS/*tms*.

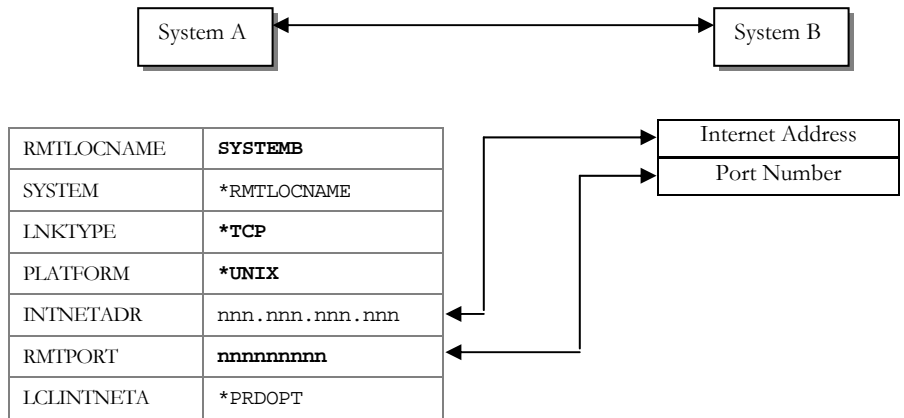

Chapter 11

Recovery

MMS/*tms* manages a wealth of information whose real value is not realized until something goes wrong. For example, the accounting department uncovered an error and they need to recover a file – a file that has been saved many times since the error occurred. To make matters worse, replication, mirroring or other high availability solutions have spread the corrupted data throughout the network. The last backup doesn't do much good in this situation. MMS/*tms*, the software that tracks and manages saved data, has the information necessary to find the data and get it recovered.

Searching for volumes can be a time consuming job but with MMS/*tms*, the wide variety of search criteria quickly identifies the volumes needed for recovery. Once the required object has been located, the correct restore command is automatically prompted so that the restore options can be tailored as needed.

This chapter discusses:

- Recovering saved document library objects
- Recovering saved integrated file system objects
- Recovering saved libraries and objects
- Recovery considerations

Recovery Overview

MMS/*tms* recovery is accomplished through the use of extensive database search facilities. These facilities provide the means to locate virtually any object saved. Once located, objects can be easily restored by selecting the restore option. If the object was saved using Media Definitions, it is restored using Media Definitions.

Working with Saved DLO

To list saved folders and documents (DLO) based on user-specified selection criteria, use **Option 3** from the MMS/*tms* Recovery menu. This prompts the Work with Saved DLO (WRKSAVDLO) command, which lists saved DLO.

Only the most current save of all document library objects known to MMS/*tms* are displayed. To view prior saves of specific folders or documents, select **Option 6** from the Work with Saved DLO panel. The amount of information available is based on the Data Retrieval Level specified when the folder and/or document was saved. Only the base volume is listed if the folder/document spanned multiple volumes when it was saved. If the folder/document is restored, MMS/*tms* will prompt for additional volumes as needed.

Restoring a Saved DLO

When the correct version of the DLO to be recovered has been located, use **Option 8** from the Work with Saved DLO menu to restore it. This prompts the IBM Restore DLO (RSTDLO) command, which restores the specified folder and/or document.

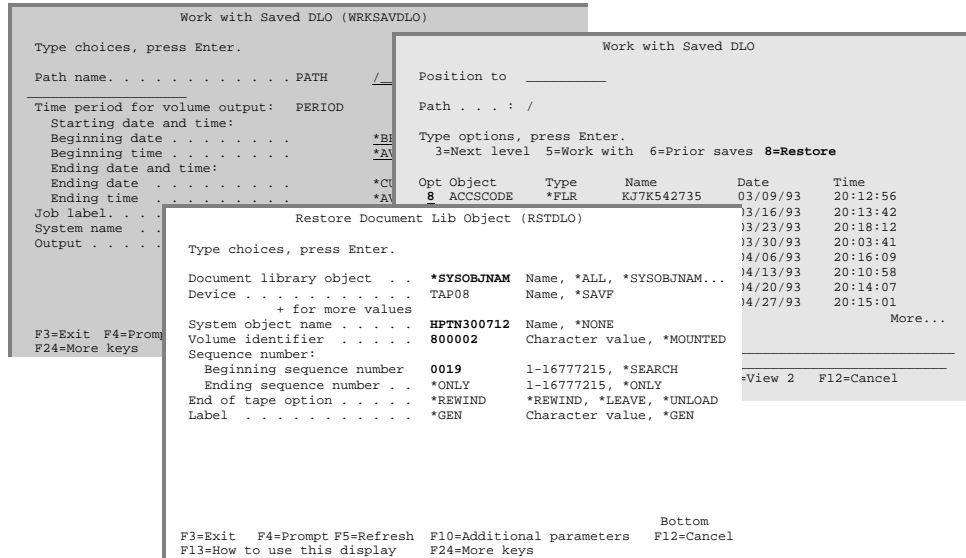

Working with Saved IFS

To list saved links based on user-specified selection criteria, use **Option 4** from the MMS/*tms* Recovery menu. This prompts the Work with Saved Link ([WRKSAVLNK](#)) command, which lists saved links.

Only the most current save of all links known to MMS/*tms* are displayed. To view prior saves of a specific link, select **Option 6** from the Work with Saved Link panel. When specifying selection criteria, in the Work with Saved link ([WRKSAVLNK](#)) command, it is recommended that only the link name be specified. This ensures that all entries satisfying the name are found, regardless of the data retrieval level used when the link was saved. Only the base volume is listed if the link spanned multiple volumes when it was saved. If the link is restored, MMS/*tms* will prompt for additional volumes as needed.

Restoring a Saved IFS

When the correct version of the saved link to be recovered has been located, use **Option 8** from the Work with Saved Link menu to restore it. This prompts the IBM Restore Object (**RST**) command, which restores the specified link.

```

Work with Saved Link (WRKSAVLNK)
Type choices, press Enter.
Object name . . . . . /_____
Time period for volume output:
Starting date and time:
Beginning date . . . . . *BEGIN
Beginning time . . . . . *AVAIL
Ending date and time:
Ending date . . . . . *CURRENT
Ending time . . . . . *AVAIL
Job label . . . . .
System name . . . . .
Output . . . . .

F3=Exit F4=Prompt
F24=More keys

Work with Saved Link
Position to _____
Path . . . : /
Type options, press Enter.
3=Next level 5=Work with 6=Prior saves 7=Full path 8=Restore
Opt Object link      Type      Date      Time
  8 dev              *DIR     09/19/04   19:32:59
                                     19:34:03
                                     20:32:58
                                     14:52:03
                                     20:32:21
                                     13:36:21
                                     09:35:24
                                     15:09:04
                                     13:16:20
More...

Restore Object (RST)
Type choices, press Enter.
Device . . . . . 'QSYS.LIB/TAPMLB02.DEVD'
Objects:
Name . . . . . '/dev'
Include or omit. . . . . *INCLUDE *INCLUDE, *OMIT
New object name. . . . . *SAME

+ for more values
Output . . . . . *NONE

Volume identifier . . . . . 800007 Char value, *MOUNTED
Label . . . . . *SAVLIB Char value, *SEARCH
Sequence number . . . . . 0282 1-1677215, *SEARCH

More...
F3=Exit F4=Prompt F5=Refresh F10-Additional parameters F12=Cancel
F13=How to use this display F24=More keys
  
```

Working with Saved Object

To list saved objects based on user-specified selection criteria, use **Option 5** from the MMS/*tms* Recovery menu. This prompts the Work with Saved Object ([WRKSAVOBJ](#)) command, which lists saved objects.

Only the most current save of all objects known to MMS/*tms* are displayed. To view prior saves of a specific object, select **Option 6** from the Work with Saved Object panel. When specifying selection criteria, in the Work with Saved Object ([WRKSAVOBJ](#)) command, it is recommended that only the object name be specified. This ensures that all entries satisfying the name are found, regardless of the data retrieval level used when the object was saved. Only the base volume is listed if the object spanned multiple volumes when it was saved. If the object is restored, MMS/*tms* will prompt for additional volumes as needed.

Restoring a Saved Object

When the correct version of the object to be recovered has been located, use **Option 8** from the Work with Saved Object menu to restore it. This prompts the IBM Restore Library (**RSTLIB**) or Restore Object (**RSTOBJ**) command, which restores the specified object.

```

Work with Saved Object (WRKSAVOBJ)
Type choices, press Enter.
Object name . . . . . LXITMS
Library . . . . . *ALL
Object type . . . . . *ALL
Time period for volume output:
Starting date and time:
Beginning date . . . . . *BEGIN
Beginning time . . . . . *AVAIL
Ending date and time:
Ending date . . . . . *CURRENT
Ending time . . . . .
Job label . . . . .
System name . . . . .
Output . . . . .

F3=Exit F4=Prompt
F24=More keys

Work with Saved Object
Position to . . . . . Starting characters
Type options, press Enter.
5=Work with 6=Prior saves 8=Restore

Opt Object Library Type Attribute Member
8 LXITMS QSYS *LIB PROD
- LXITMS QSYS *LIB PROD
- LXITMS QSYS *LIB PROD

Restore Library (RSTLIB)
Type choices, press Enter.
Saved library . . . . . LXITMS Name, *NONSYS, *ALLUSR, *IBM
Device . . . . . TAP09 Name, *SAVF
+ for more values
Volume identifier . . . . . 800007 Character value, *MOUNTED...
Sequence number . . . . . 0082 1-9999, *SEARCH
Label . . . . . *SAVLIB
End of tape option . . . . . *REWIND *REWIND, *LEAVE, *UNLOAD

Additional Parameters
Option . . . . . *ALL *ALL, *NEW, *OLD, *FREE
Data base member option . . *MATCH *MATCH, *ALL, *NEW, *OLD
Date when saved . . . . . Date
Time when saved . . . . . Time
Allow object differences . . *NONE *NONE, *ALL
Restore to library . . . . . *SAVLIB Name, *SAVLIB

F3=Exit F4=Prompt F5=Refresh F12=Cancel F13=How to use this display
F24=More keys
    
```

Restore Considerations

Only the most current save of all objects saved by MMS/*tms* is displayed. Prior saves of specific objects, if available, can be viewed by selection **Option 6** from the appropriate panel. The amount of information available is based on the Data Retrieval Level specified when the save occurred. Refer to [Chapter 13, Using Data Retrieval](#), for details on establishing the retrieval level.

When the object is restored through the Work with Saved Object, Work with Saved DLO or Work with Saved Link panel, MMS/*tms* fills in the command parameters.

The device specified on the restore command is the same device specified when the object was saved. If the device is not available, it can be changed. If the device is in a tape library and MMS/*tms* device management is used, MMS/*tms* finds an available device if the specified drive is not available. If device management is not used and a tape needs to be mounted, an inquiry message will be sent to the requestor.

Restoring from a Remote Save

The Work with Saved Object ([WRKSAVOBJ](#)), Work with Saved DLO ([WRKSAVDLO](#)) and Work with Saved Link ([WRKSAVLNK](#)) provide the ability to work with objects saved on a remote system. Using **Option 8** restores the remote saved object to the local (source) system. If the tape is not mounted, an inquiry message is issued to the System Operator.

Using the Recovery Report

The Print Recovery Volumes ([PRTRCYVOL](#)) command provides a report that lists the volumes associated with up to 300 Job Labels. This report can be run interactively or scheduled in a job scheduler. It should be run daily to provide a report that easily identifies the volumes required in the event of a disaster. This report can be run for from any system in the MMS/*tms* network for any system in the MMS/*tms* network. Options include the ability to determine the amount of information to print per Job Label. Refer to [Chapter 16, Reports](#), for a sample of the Recovery Report.

Chapter 12

Customizing MMS/tms

Not everyone wants or needs the same thing. MMS/*tms* provides options that can be implemented for those that need them and removed for those that have no need for them. Since data center environments are varied, the options can be tailored to match them. If an option needs to be implemented or removed, it can be done with minimal effort. The options provided may be required in order for other functions to work properly. An example of this would be tape libraries. This chapter discusses:

- Types of customization options available
- Customization requirements
- Customizing MMS/*tms*

MMS/*tms* Customization Overview

When any tape function is used, the product options are checked to determine the type of support required. If an option is implemented, it is performed at the appropriate time.

MMS/*tms* Options

The following options can be installed, removed or changed as required:

- Default Location Name
- Default Retrieval Level
- Non-labeled Tape Support
- Communication Options

Enhanced Command Support

This support, which enhances IBM tape commands by providing additional functionality, is added when MMS/*tms* is attached and removed when MMS/*tms* is detached. Use the Change Product Status ([CHGPRDSTS](#)) command to attach or detach MMS/*tms*. The increased functionality includes:

- Allocation/de-allocation of tape devices
- Retrieval of volume content information
- Interfaces to non-IBM tape libraries

In addition to the above listed enhancements, the following functionality has been added to the **INZTAP** command:

- Verify the volume status (active/scratch)
- Verify that the new volume identifier is available for use
- Verify the volume identifier matches the user-defined format
- Automatically generate the next sequential volume identifier
- Automatically initialize up to 99 volumes with one execution
- Automatically mount and dismount volumes from tape libraries
- Provide warning when changing a volume from ***SL** to ***NL**

Default Location Name

The default location is the name of the location where the tape volumes reside when they are not in an off-site location. This location is usually the data center but the name can be changed from the default value of ***DFTLOC** to another value. Changing the name of the default location has no effect on the MMS/*tms* database. This value is used for display purposes only.

Default Retrieval Level

The default retrieval level is used when ***USRDFN** is specified in the Job Label but the user-defined retrieval level for the library has not been entered. If the retrieval level has not been set for any library, this value is used. A value of ***MBR** causes disk space and MMS/*tms* processing resources to increase.

Non-labeled Tape Support

Non-labeled tape support allows tapes, without a standard label, to be tracked. This support prompts the operator for a volume identifier when a non-labeled tape is encountered. Since non-labeled tapes do not have save date/time and expiration information, MMS/*tms* defaults the save date/time to the current date/time and the expiration date based on the Job Label.

For additional information on how MMS/*tms* initializes non-labeled tapes, see [Chapter 6, *Managing Devices*](#).

Local Host Name

If TCP/IP communications is used to communicate with other tape management systems, this value specifies the local host name that is used when connecting to the remote system. To use the current system name specified in the network attributes, specify ***NETATR**, otherwise, specify a local host name.

Local Internet Address

If TCP/IP communications is used to communicate with other tape management systems, this value specifies the local Internet address of the communication link of the outbound data.

Local Port Number

If TCP/IP communications is used to communicate with other tape management systems, this value specifies the local port number used by the MMS/*tms* communications server. Ports 1 through 1023 are used by system-supplied **TCP/IP** applications.

Remote Port Number

If TCP/IP communications is used to communicate with other tape management systems, this value specifies the remote port number used by the MMS/*tms* communications server. Ports 1 through 1023 are used by system-supplied **TCP/IP** applications.

Communications Recovery Wait

Specifies the amount of time (in minutes) that the Communications Recovery Manager waits before checking for remote systems that are not responding.

Customizing MMS/tms

To change an option, detach MMS/tms from OS/400. Options cannot be changed as long as MMS/tms is attached. Use the Change Product Status ([CHGPRDSTS](#)) command to detach MMS/tms.

Changing Options

To change the options, use the Tab key to tab to the Setup menu. Press **Enter** to view the options available from the pull-down menu. Select **Option 2** from the Setup menu. This prompts the Change Product Options ([CHGPRDOPT](#)) command, which changes the current values.

```

Setup  Communications  Go  Help
-----
 2 1. Status
 2 2. Options
-----
following:
 1. Work with Job label
 2. Work with Volume
10. Reports
-----
Related Command Menus
 80. Communication Link Commands
 81. Job Label Commands
 82. Security Commands
 83. Tape Commands
 84. Volume Commands
-----
Selection or command
====>
-----
F3=Exit F4=Prompt F9=Retrieve F12=Cancel

Change Product Options (CHGPRDOPT)
Type choices, press Enter.
Product identifier . . . . . *TMS      *TMS
Default location name . . . . . *DFTLOC Name, *DFTLOC
Default retrieval level . . . . . *LIB      *LIB, *OBJ, *MBR
Nonlabeled tape support . . . . . *YES      *NO, *YES
Local host name . . . . . *NETATR  Name, *NETATR
Local Internet address . . . . . *ANY
Local port number . . . . . *NONE     1-65535, *NONE
Remote port number . . . . . *NONE     1-65535, *NONE
Communications recovery wait . . . . . 003600  1-999999
-----
Bottom
F3=Exit F4=Prompt F5=Refresh F12=Cancel F13=How to use this display
F24=More keys
    
```

Command Changes

Enhanced command changes are performed by using an IBM exit program. This exit program eliminates the need to have a library containing modified versions of the commands in front of QSYS in the library list. When a command that is enhanced by MMS/tms is entered, the replaced command string will be logged to the job log only when the original command was logged. For commands entered on a command line, the original command will be logged as a request message, and the substitute will be logged as a command message. This will allow users to retrieve their original command with the Retrieve function key.

Chapter 13

Using Data Retrieval

MMS/*tms* supports volumes and volume contents. Volume contents are an **index** of what is on a tape. This index can be a simple name, such as a data set name, or it can contain more detail, such as object name, library, object type and attribute. Volume contents provide the information necessary for recovery. The amount of detail required is based on the importance of the object during recovery. If the possibility of restoring an object into a library is remote, such as an IBM library, then the need for detailed information on the library is not necessary. If a library or its objects are constantly being restored, the need for detail information may be more important. Volume contents use disk space. The more information required, the more disk space used. Volume contents require resources. The more information required, the more CPU processing required.

This chapter discusses:

- Types of retrieval levels
- How to establish retrieval levels
- Retrieval level considerations

Data Retrieval Level Overview

The **data retrieval level** determines the amount of information that MMS/*tms* captures for a saved object.

When a save starts, MMS/*tms* retrieves the data retrieval level from either the Job Label, if specified, or from the MMS/*tms* system default. Depending on the values specified, MMS/*tms* retrieves the level of detail requested from the save process and uses it to update the database when the save completes.

Retrieval Level Requirements

Retrieval levels provide the user with the ability to control how much information to retain in the MMS/*tms* databases. Retrieval levels are specified at the Job Label level.

DLO Support

Document library objects can be tracked. These objects are displayed the same way as they are on disk. The available options include:

- *ALL - All saved folders/documents are tracked
- *BASIC - Individual folders/documents are not tracked

Integrated File System Support

Integrated File System (IFS) objects can be tracked. These objects are displayed the same way as they are on disk. The available options include:

- *ALL - All saved IFS objects are tracked
- *BASIC - No saved IFS objects are tracked

Lotus Notes/Domino Support

Domino/Lotus Notes objects can be tracked. These objects are displayed the same way as they are on disk. The available options include:

- *ALL - All saved Domino/Lotus Notes objects are tracked
- *BASIC - No saved Domino/Lotus Notes objects are tracked

Object Support

Libraries and the objects within them can be tracked at three different levels. The retrieval level and the information retrieved is:

- *LIB - Only the library name is tracked
- *OBJ - Every saved object is tracked
- *MBR - Every object and database member is tracked

Save File Support

Save file support allows the contents of first level save files to be written to the MMS/*tms* database. The available options include:

- *ALL - Save file contents are tracked
- *BASIC - Save file contents are not tracked

Default Retrieval Level

The default retrieval level is used when the retrieval level does not exist at the job level. The system value is specified in the Product Options ([CHGPRDOPT](#)) command. The options available at the system level are:

- *LIB - Only the library name is listed
- *OBJ - Every saved object is listed
- *MBR - Every object and database member is listed

Job Retrieval Level

The retrieval level for the job is specified in the Job Label. The objects saved are retrieved at the same retrieval level if a value other than *USRDFN is specified. The options available at the job level are:

- *LIB - Only the library name is listed
- *OBJ - Every saved object is listed
- *MBR - Every object and database member is listed
- *USRDFN - Retrieval level is user-defined (library level)

Specifying *USRDFN

Specifying *USRDFN at the Job Label level provides the ability to specify a different retrieval level for each library. Since the retrieval level is specified for each library, there is a performance impact. This value should only be used if there is a requirement to have different retrieval levels for objects saved with this Job Label.

Working with Job Retrieval Levels

To view the retrieval level of DLO, Domino, IFS, objects and save files use the Work with Job Label ([WRKJOBLBL](#)) command and press **Enter**. Pressing **F11** twice will display the Retrieval levels associated with the Job Labels.

Changing the Job Retrieval Level

To change a Job Labels retrieval level, use **Option 2** from the Work with Job Label panel. This prompts the Change Job Label ([CHGJOBLBL](#)) command, which changes the current values. The retrieval level for all supported objects types can be changed. The changed values take effect the next time a save is performed.

```

Work with Job Label
-----
Position to . . . . . Starting ch
Type options, press Enter.
1=Add 2=Change 3=Move Job 4=Delete 5=Work with Job Label
8=Saved Objects 9=Reference
-----Retrieval
Opt Job Label      DLO      Domino  IFS
-----
- *DFT             *BASIC *BASIC  *BASIC
- DAILY           *ALL   *ALL    *ALL
2 WEEKLY          *ALL   *ALL    *ALL
- MONTHLY         *ALL   *ALL    *ALL

Selection or command
====>

F3=Exit F4=Prompt F9=Retrieve F10=View 4
F15=Retrieval level

Change Job Label (CHGJOBLBL)
-----
Type choices, press Enter.
Job label . . . . . WEEKLY Name, *DFT
Data Retention:
Generations . . . . . 0 0-9999
Days . . . . . 30 0-9000, *PERM
Type of information to retain:
Document library object . . . *BASIC *SAME, *BASIC, *ALL
Lotus Notes/Domino . . . . . *BASIC *SAME, *BASIC, *ALL
Integrated file system . . . *BASIC *SAME, *BASIC, *ALL
Libraries and objects . . . *LIB *SAME, *LIB, *OBJ, *MBR...
Save files . . . . . *BASIC *SAME, *BASIC, *ALL...
Referenced tape pool . . . . *JOBLBL
System . . . . . *Name, *CURRENT
Print volume label . . . . . *NO *NO, *YES
Text 'description' . . . . . Weekly Backups

Bottom
F3=Exit F4=Prompt F5=Refresh F12=Cancel F13=How to use this display
F24=More keys
    
```

Working with *USRDFN Levels

If the retrieval level of a Job Label specifies user-defined (*USRDFN), the retrieval level for a saved object is controlled at the library level. The amount of information gathered for a saved object can be changed as required. To work with the retrieval level of libraries, press **F15** from the Work with Job Label panel.

Adding Library Retrieval Level

To add the retrieval level for one or more libraries, press **F13** from the Work with Retrieval Level panel. This displays a list of all libraries on the system. Select the libraries to add and press **Enter**. This prompts the Add Retrieval Level ([ADDRTVLVL](#)) command, which specifies the retrieval level and adds the library to the object retrieval list.

The screenshot shows two side-by-side panels from the 'Work with Retrieval Level' application.

Left Panel: Work with Retrieval Level

- Position to Starting
- Type options, press Enter.
2=Change 4=Delete
- Information-----
- Opt Library Retrieval Save File Text
- Selection or command
==>
- F3=Exit F4=Prompt F5=Refresh F9=Retrieval

Right Panel: Select library

- Position to
- Type options, Press Enter.
1=Select
- Opt Library Text
- #CGULIB
- #DFULLIB
- #DSULLIB
- #RFGLLIB
- #SDALIB
- #SEHLLIB
- ACCTPGMLIB Account Program Library
- 1 ACCTFILLIB Account File Library
- APPGMLIB A/P Program Library
- 1 APFLLIB A/P File Library
- ARPGMLIB A/R Program Library
- 1 ARFLLIB A/R File Library
- F12=Cancel
- More...

Tip: If the retrieval level for a library is equal to the default retrieval level specified in the product options, it does not need to be selected.

Changing Library Retrieval Level

To change a library's retrieval level, use **Option 2** from the Work with Retrieval Level panel. This prompts the Change Retrieval Level ([CHGRTVLVL](#)) command, where the current values can be changed. The changed values take effect the next time the object is saved.

Deleting Library Retrieval Level

To delete the retrieval level for one or more libraries, use **Option 4** from the Work with Retrieval Level panel. This deletes the library retrieval level entry. If the library or any of the objects within the library are saved, the retrieval level will default to the default retrieval level.

Retrieval Level Examples

The following examples illustrate how to establish retrieval levels for a save job. Example 1 shows how to setup a retrieval level based on the job and Example 2 shows how to setup the retrieval level based on the library being saved.

Job Retrieval Level Example

To specify a retrieval level at the Job Label level, use the Work with Job Label ([WRKJOBLBL](#)) command to list all or specific Job Labels. Select a Job Label using **Option 2** from the Work with Job Label panel. This prompts the Change Job Label ([CHGJOBLBL](#)) command where jobs' retrieval level can be specified.

In the following illustration, a retrieval level of ***OBJ** is specified for Job Label **WEEKLY**. This means that objects saved with this Job Label have the saved *object* information written to the MMS/*tms* database. Note that no detail is tracked for the DLO, Domino and IFS saves. Save file contents are also not tracked at detail level.

```

Work with Job Label
-----
Position to . . . . . Starting ch
Type options, press Enter.
1=Add 2=Change 3=Move Job 4=Delete 5=Work with Job Label
8=Saved Objects 9=Reference

Opt Job Label -----Text-----
- *DFT Default Job Label
- DAILY Daily Backups
- 2 WEEKLY Weekly Backups
- MONTHLY Monthly Backups

Selection or command
====>

F3=Exit F4=Prompt F9=Retrieve F10=View 4
F15=Retrieval level

Change Job Label (CHGJOBLBL)
-----
Type choices, press Enter.
Job label . . . . . WEEKLY Name, *DFT
Data Retention:
Generations . . . . . 0 0-9999
Days . . . . . 30 0-9000, *PERM
Type of information to retain:
Document library object . . . *BASIC *SAME, *BASIC, *ALL
Lotus Notes/Domino . . . . . *BASIC *SAME, *BASIC, *ALL
Integrated file system . . . . *BASIC *SAME, *BASIC, *OBJ
Libraries and objects . . . . . *OBJ *SAME, *LIB, *OBJ, *MBR...
Save files . . . . . *BASIC *SAME, *BASIC, *ALL...
Referenced tape pool . . . . . *JOBLEBL
System . . . . . *Name, *CURRENT
Print volume label . . . . . *NO *NO, *YES
Text 'description' . . . . . Weekly Backups

Bottom
F3=Exit F4=Prompt F5=Refresh F12=Cancel F13=How to use this display
F24=More keys
    
```

Library Retrieval Level Example

To specify a retrieval level at the library level, use the Work with Job Label ([WRKJOBLBL](#)) command to list all or specific Job Labels. Select a Job Label using **Option 2** from the Work with Job Label panel. This prompts the Change Job Label ([CHGJOBLBL](#)) command, where the job retrieval level can be specified.

In the following example, a retrieval level of ***USRDFN** is specified for Job Label **WEEKLY**. This means that libraries saved with this Job Label contain information based on the individual libraries retrieval level.

```

Work with Job Label
-----
Position to . . . . . Starting ch
Type options, press Enter.
  1=Add  2=Change  3=Move Job  4=Delete  5=Work with
  8=Saved Objects  9=Reference

Opt Job Label -----Text-----
-
- *DFT      Default Job Label
- DAILY     Daily Backups
- 2 WEEKLY  Weekly Backups
- MONTHLY  Monthly Backups

Selection or command
====>

F3=Exit  F4=Prompt  F9=Retrieve  F10=View  4
F15=Retrieval level

Change Job Label (CHGJOBLBL)
-----
Type choices, press Enter.
Job label . . . . . WEEKLY  Name, *DFT
Data Retention:
  Generations . . . . . 0      0-9999
  Days . . . . . 30      0-9000, *PERM
Type of information to retain:
  Document library object . . . *BASIC *SAME, *BASIC, *ALL
  Lotus Notes/Domino . . . . . *BASIC *SAME, *BASIC, *ALL
  Integrated file system . . . . *BASIC *SAME, *BASIC, *ALL
  Libraries and objects . . . . . *USRDFN *SAME, *LIB, *OBJ, *MBR...
  Save files . . . . . *USRDFN *SAME, *BASIC, *ALL...
  Referenced tape pool . . . . . *JOBLBL
  System . . . . . _____ *Name, *CURRENT
  Print volume label . . . . . *NO      *NO, *YES
  Text 'description' . . . . . Weekly Backups

Bottom
F3=Exit F4=Prompt F5=Refresh F12=Cancel F13=How to use this display
F24=More keys
  
```

If the retrieval level for the library being added is equal to the default retrieval level specified in the product options, it does not need to be added to the retrieval list. To specify a library's retrieval level, press **F15** from the Work with Job Label panel. This prompts the Work with Retrieval Level ([WRKRTVLVL](#)) command. Pressing **Enter** displays the Work with Retrieval Level panel.

```

Work with Job Label
-----
Position to . . . . . Starting ch
Type options, press Enter.
  1=Add  2=Change  4=Delete  5=Work with

Opt Job Label -----Text-----
-
- *DFT      Default Job Label
- DAILY     Daily Backups
- WEEKLY    Weekly Backups
- MONTHLY  Monthly Backups
- ARBKUP   A/R Backups
- APBKUP   A/P Backups

Selection or command
====>

F3=Exit  F4=Prompt  F9=Retrieve  F11=View
F15=Retrieval level

Work with Retrieval Level (WRKRTVLVL)
-----
Type choices, press Enter.
Retrieval level type . . . *LIB      *LIB, *DIR
Library . . . . . *ALL      Name, generic*, *ALL

Bottom
F3=Exit F4=Prompt F5=Refresh F12=Cancel F13=How to use this display
F24=More keys
  
```

To add the retrieval level for one or more libraries, press **F13** from the Work with Retrieval Level panel. This displays a list of all libraries on the system. Selecting libraries to add and pressing **Enter** prompts the Add Retrieval Level ([ADDRTVLVL](#)) command, which specifies the retrieval level and adds the library to the retrieval list.

```

Work with Retrieval Level
-----
Position to . . . . . Starting
Type options, press Enter.
  2=Change  4=Delete

-----Information-----
Opt Library      Retrieval  Save File  Text
-----
Selection or command
===>

F3=Exit  F4=Prompt  F5=Refresh  F9=Retrieval

Select library
-----
Position to . . . . .
Type options. Press Enter.
  1=Select

Opt  Library      Text
--  -
--  #CGULIB
--  #DFULLIB
--  #DSULLIB
--  #RFGLIB
--  #SDALIB
--  #SEULIB
--  ACCTPGMLIB  Account Program Library
  1 ACCTFILLIB  Account File Library
--  APFGMLIB   A/P Program Library
  1 APFILLIB   A/P File Library
--  ARPGMLIB   A/R Program Library
  1 ARFILLIB   A/R File Library

F12=Cancel
More...

```

Performance Considerations

Caution should be used when specifying a system value of ***OBJ** or ***MBR**. To retrieve this level of information for every object saved creates significant overhead and uses a lot of disk space. For more information about the disk space requirements for the various retrieval levels, refer to the Change Retrieval Level ([CHGRTVLVL](#)) command.

Caution should be used when specifying ***USRDFN** in a Job Label. This value causes MMS/*tms* to retrieve information at ***MBR** level for all libraries saved with the Job Label and then update the database as specified by the saved objects retrieval level.

Performance of data retrieval, as well as OS/400 performance, can be *significantly improved* if save commands process as many libraries in one execution of the command as feasible. The save commands allow up to 300 libraries to be specified. If this method of saving is used, the impact on processing time will be minor.

File Size Considerations

Retrieval level processing creates work files, which are used to gather information for the database. If the library being saved contains a large number of objects, the default number of records that can be created for a file may be exceeded. If this occurs, an inquiry message is issued to the System Operator requesting that the file be extended. The user may extend the file or cancel the job.

To prevent this condition from occurring, it is recommended that the default size for the IBM save work file database be increased. This prevents the save process from stopping if the default file size has been exceeded. To change the size of the IBM save work file, use the IBM Change Physical File (**CHGPF**) command. In the following example, the default size of the IBM work files for the save commands are changed to ***NOMAX**.

```
CHGPF FILE(QASAVOBJ) SIZE(*NOMAX)
```

```
CHGPF FILE(QAOJSAVO) SIZE(*NOMAX)
```

Retrieval Levels and Outfiles

User output files can be created from most of the MMS/*tms* enhanced save commands. If specified, the retrieval level of the save job is the same as specified in the **RTVLVL** parameter of the Job Label.

Chapter 14

Using Tape Libraries

MMS/*tms* supports any IBM, Memorex/Telex (MTX) or StorageTek (STK) tape library that can be used on the iSeries. Using tape libraries helps automate tape functions such as backups, restores, archives, and data recalls without operator intervention. These libraries range in size and can contain from 20 tapes up to thousands of tapes. When a tape function is performed, the tape library mounts a tape based on user requirements, performs the function and unloads the tape when complete. Tape libraries can have multiple tape devices and can provide tape access to multiple systems and/or platforms.

This chapter discusses:

- Tape library processing
- How to enable MMS/*tms* with a tape library
- Tape library considerations

Tape Library Support Overview

MMS/*tms* tape library support requires two parts: **Device Definition** and **Job Label**. These functions help maximize the usage of the tape library.

The Device Definition defines the type of tape library and the name of the library device. When a volume is requested through a tape command, MMS/*tms* uses the Device Definition to determine which tape library commands to use to mount the volume. Some libraries require that a tape device be allocated prior to use. This is accomplished through the MMS/*tms* Enhanced Command Support or through MMS/*tms* or vendor specific allocate/de-allocate processes.

The Job Label provides MMS/*tms* with the range of volumes allowed for a tape library. If a tape library is shared between multiple systems and/or platforms, the Job Label ensures that the correct volumes are assigned to the system.

Additional support is provided for library synchronization and restricted state processing. Library synchronization ensures that the tape library and MMS/*tms* stay synchronized. Some libraries require additional processes before being used in restricted state. MMS/*tms* provides support for these libraries.

Device Definition Requirements

MMS/*tms* requires a Device Definition for each device in a tape library. If an IBM tape library is used, the **MLB** (Media Library) must also be defined. Refer to [Chapter 6, *Managing Devices*](#) for information on Device Definitions.

Ejecting Volumes from Tape Libraries

MMS/*tms* provides support for ejecting volumes from all supported automated tape libraries through the Eject Volume ([EJTVOL](#)) command. Volumes can be ejected by volume identifier or by Job Label.

Synchronizing Tape Libraries

MMS/*tms* provides a method of synchronizing tape libraries with the MMS/*tms* database. This process is required when a tape library is first enabled with MMS/*tms*. The Update Tape Library ([UPDTAPLIB](#)) command synchronizes the tapes in the tape library with the MMS/*tms* database.

StorageTek Considerations

The following must be observed when using StorageTek automated tape libraries.

- When adding tapes to the tape library, use the MMS/*tms* Enter Volume ([ENTVOL](#)) command.

Working with Tape Libraries

The Work with Tape Library ([WRKTAPLIB](#)) command lists all volumes that currently reside in a tape library. Volumes can be listed by volume status, such as active or scratch or by system. The following example lists all scratch volumes for a tape library named **TAPLIB01**. Options include the ability to work with, eject, scratch, initialize, dump and display tapes.

```
Work with Tape Library (WRKTAPLIB)
Type choices, press Enter.
Library device . . . . . TAPLIB01
Volume Status . . . . . *SCR
System name . . . . . *ALL
Output . . . . . _

F3=Exit F4=Prompt F5=Refresh F12=Cancel F
F24=More keys

Work with Tape Library
Position to . . . . . _____ Volume identifier
Library . . . . . : TAPLIB01

Type options, press Enter.
4=Eject 5=Work with 8=Data 10=Initialize 11=Display 13=Dump
14=Duplicate 15=Check

Opt Volume Date Time Status -----Text-----
- 800000 09/11/04 20:22:41 *SCR LXI Daily - Production - D
- 800002 09/16/04 08:04:18 *SCR LXI Daily - Production - D
- 800035 09/17/04 20:32:31 *SCR LXI Daily - Production - D

Selection or command Bottom
====>

F3=Exit F4=Prompt F5=Refresh F9=Retrieve F10=View 4 F11=View 2
F12=Cancel F15=Eject F16=Update
(c) Copyright LXI Corp. 1985, 2006
```

Ejecting Volumes

Using **Option 4** from the Work with Tape Library panel prompts the Eject Volume ([EJTVOL](#)) command. This allows tape volumes to be ejected from the tape library and placed in the output station associated with the tape library.

Displaying Volume Contents

Using **Option 8** from the Work with Tape Library panel initiates the Display Volume Data ([DSPVOLDTA](#)) command which displays the contents of the tape.

Initialize Tape

Using **Option 10** from the Work with Tape Library panel initiates the Initialize Tape ([INZTAP](#)) command which reformats the tape.

Display Tape

Using **Option 11** from the Work with Tape Library panel initiates the IBM Display Tape (DSPTAP) command which displays the volume label and data file label information.

Dump Tape

Using **Option 13** from the Work with Tape Library panel initiates the IBM Dump Tape (DMP TAP) command which dumps label information and/or data blocks.

Duplicate Tape

Using **Option 14** from the Work with Tape Library panel initiates the IBM Duplicate Tape (DUPTAP) command which duplicates one tape to another.

Check Tape

Using **Option 15** from the Work with Tape Library panel initiates the IBM Check Tape (CHKTAP) command which searches the volume for a unique volume identifier or file label.

IBM Tape Library Configuration

- From a command line, type [WRKTAPDEV](#) and press **Enter**. Press **F6** to automatically configure all devices defined to OS/400. When the message “*Auto-configuration is complete.*” is displayed, press **F5** to view all configured devices.

```

Work with Tape Device
Position to . . . . . Starting characters
Type options, press Enter.
  1=Add 2=Change 4=Delete 8=Usage 9=Library 13=History
Opt Device  Type  Description
-  - - - - -
                                           Bottom
Selection or command
====>

F3=Exit   F4=Prompt  F5=Refresh  F6=Auto Config.  F9=Retrieve
F11=View 2 F12=Cancel F15=Status
  
```

- To specify optional tape pools, use **Option 8** on the tape library definition. This displays the tape usage information.

```

Work with Tape Device
Position to . . . . . Starting characters
Type options, press Enter.
  1=Add 2=Change 4=Delete 8=Usage 9=Library 13=History
Opt Device  Type  Description
  8 TAPMLB01 3494 IBM 3494 Tape Library
- TAP04    3590 IBM 3590 in the 3494 Tape Library
- TAP05    3590 IBM 3590 in the 3494 Tape Library
                                           Bottom
Selection or command
====>

F3=Exit   F4=Prompt  F5=Refresh  F6=Auto Config.  F9=Retrieve
F11=View 2 F12=Cancel F15=Status
  
```

- Select **Option 2** from the Work with Tape Usage panel. This prompts the Change Tape Usage ([CHGTAPUSG](#)) command, which defines the range of volumes allowed.

```

Work with Tape Usage
Device: TAPMLB01
Type options, press Enter.
  2=Change 8=Volumes
-----Tape Pool-----
Opt Density  R/W  Beginning Ending Error
- *FMT3590   R   *BEGIN  *END  *IGNORE
  2 *FMT3590E R/W *BEGIN  *END  *IGNORE
                                           Bottom
Selection or command
====>

F3=Exit   F4=Prompt  F9=Retrieve  F11=View 2  F12=Cancel
(c) Copyright LXI Corp. 1985, 2006
  
```

- If needed, change the beginning and ending range to include the entire range of volumes allowed in the tape library (even though the entire range may not be in the library). Change the Tape range error to ***REJECT** and press **Enter**.

```

Change Tape Usage (CHGTAPUSG)

Type choices, press Enter.
Device name . . . . . TAPMLB01      Name, *ANY
Tape Density . . . . . *FMT3590     *DEVTYPE, *QIC120, 10000...
Initialize:
  Format . . . . . 0NNNNN           Character value, *SAME
  Number . . . . . 000000          Character value, *SAME
  Allow format change. . *YES       *SAME, *NO, *YES
Tape Pool:
  Beginning . . . . . 000000       Character value, *SAME...
  Ending . . . . . 009999         Character value, *SAME, *END
  Tape range error . . . *REJECT   *SAME, *IGNORE, *REJECT
Owner . . . . . *ANY              Character value, *SAME...
+ for more values _____

Bottom
F3=Exit F4=Prompt F5=Refresh F12=Cancel F13=How to use this display
F24=More keys
    
```

- The tape pool is used to select volumes for the tape library. Any volume in the device that is not within range is rejected from the device and replaced with a volume that is within the range. Press **Enter** twice to exit the Work with Tape Device panel.

```

Work with Tape Usage

Device: TAPMLB01

Type options, press Enter.
  2=Change  8=Volumes

-----Tape Pool-----
Opt Density  R/W  Beginning Ending Error
- *FMT3590   R    001000  001999 *REJECT
- *FMT3590E  R/W  001000  001999 *REJECT

Bottom

Selection or command
====>

F3=Exit  F4=Prompt  F9=Retrieve  F11=View 2  F12=Cancel
(c) Copyright LXI Corp. 1985, 2006
    
```

- To work with the volumes in a tape library, prompt the Work with Tape Library (**WRKTAPLIB**) command from a command line. Enter the name of the library device and press **Enter**. This displays the Work with Tape Library panel.

```

Work with Tape Library (WRKTAPLIB)

Type choices, press Enter.

Library device . . . . . TAPMLB01   Name
Volume Status . . . . . *SCF        *ALL, *ACT, *ERR, *GEN...
System name . . . . . *ALL          Name, *LCL, *ALL
Output . . . . . *                  *, *PRINT, *OUTFILE

Bottom
F3=Exit F4=Prompt F5=Refresh F12=Cancel F13=How to use this display
F24=More keys
    
```

7. To synchronize the tape library volumes with the MMS/*tms* database, press **F16**. This prompts the Update Tape Library ([UPDTAPLIB](#)) command.

```

Work with Tape Library

Position to . . . . . _____ Volume identifier
Library . . . . . : TAPLIB01

Type options, press Enter.
 4=Eject 5=Work with 8=Data 10=Initialize 11=Display 13=Dump
14=Duplicate 15=Check

Opt Volume Date      Time      Status -----Text-----
- 001827 09/11/04    20:22:41 *SCR LXI Daily - Production - D
- 003827 09/16/04    08:04:18 *SCR LXI Daily - Production - D
- 006615 09/17/04    20:32:31 *SCR LXI Daily - Production - D

                                                    Bottom

Selection or command
====>

F3=Exit F4=Prompt F5=Refresh F9=Retrieve F10=View 4 F11=View 2
F12=Cancel F15=Eject F16=Update
(c) Copyright LXI Corp. 1985, 2006

```

8. Pressing **Enter** synchronizes the IBM tape library with the MMS/*tms* database on the local system.

```

Update Tape Library (UPDTAPLIB)

Type choices, press Enter.

Library device . . . . . TAPMLB01 Name
Remote library device . . . *NONE Name, *NONE, *ALL
System. . . . . _____ Name
+ for more values _____

                                                    Bottom

F3=Exit F4=Prompt F5=Refresh F12=Cancel F13=How to use this display
F24=More keys

```

9. When complete, press **F5** from the Work with Tape Library panel to update the panel list.

```

Work with Tape Library

Position to . . . . . _____ Volume identifier
Library . . . . . : TAPLIB01

Type options, press Enter.
 4=Eject 5=Work with 8=Data 10=Initialize 11=Display 13=Dump
14=Duplicate 15=Check

Opt Volume Date      Time      Status -----Text-----
- 001827 09/11/04    20:22:41 *SCR LXI Daily - Production - D
- 003827 09/16/04    08:04:18 *SCR LXI Daily - Production - D
- 006615 09/17/04    20:32:31 *SCR LXI Daily - Production - D

                                                    Bottom

Selection or command
====>

F3=Exit F4=Prompt F5=Refresh F9=Retrieve F10=View 4 F11=View 2
F12=Cancel F15=Eject F16=Update
(c) Copyright LXI Corp. 1985, 2006

```

Synchronizing the IBM Library

The Update Tape Library ([UPDTAPLIB](#)) command should be run when:

- the tape library is powered off/on
- tapes are added outside of MMS/*tms*
- tapes are removed outside of MMS/*tms*

The MMS/*tms* database is also synchronized when the IBM Work with Tape Cartridge (WRKTAPCTG) command is used.

MTX Tape Library Configuration

- From a command line, type [WRKTAPDEV](#) and press **Enter**. Press **F6** to automatically configure all devices defined to OS/400. When the message “*Auto-configuration is complete.*” is displayed, press **F5** to view all configured devices.

```

Work with Tape Device
Position to . . . . . Starting characters
Type options, press Enter.
  1=Add  2=Change  4=Delete  8=Usage  9=Library  13=History
Opt Device  Type  Description
-----
Selection or command
====>

F3=Exit  F4=Prompt  F5=Refresh  F6=Auto Config.  F9=Retrieve
F11=View 2  F12=Cancel  F15=Status
  
```

- Use **Option 2** to change the devices that reside in the MTX tape library. This prompts the Change Tape Device ([CHGTAPDEV](#)) command.

```

Work with Tape Device
Position to . . . . . Starting characters
Type options, press Enter.
  1=Add  2=Change  4=Delete  8=Usage  9=Library  13=History
Opt  Device  Type  Description
---  -
  2  TAP04     3590  3590 in the 5100 MTX Tape Library
  2  TAP05     3590  3590 in the 5100 MTX Tape Library
Selection or command
====>

F3=Exit  F4=Prompt  F5=Refresh  F6=Auto Configure  F11=View 2
F11=View 2  F12=Cancel  F15=Status
  
```

- Specify ***MTX** for the library type and enter the name of the library device and the destination for volumes being ejected. Change the **USAGE** parameter, if needed. Press **Enter** when complete.

```

Change Tape Device (CHGTAPDEV)
Type choices, press Enter.
Device . . . . . > TAP04      Name, *DPT
Share device . . . . . *YES    *SAME, *NO, *YES
Function supported . . *ALL  *READ, *WRITE, *ALL
Usage . . . . . *ANY      *ANY, *NEXT, *LAST
Tape library information:
Library type . . . . . *MTX    *NONE, *IBM, *MTX, *STKDA...
Library device . . . . ATL01  Name, *NONE
Destination . . . . . *CAS    Name, *CAS, *CNV, *DEV...
Selection or command
====>

F3=Exit  F4=Prompt  F5=Refresh  F12=Cancel  F13=How to use this display
F24=More keys
  
```

- To specify optional tape pools, use **Option 8** on the Device Definitions. This displays the tape usage information.

```

Work with Tape Device
-----
Position to . . . . . Starting characters
Type options, press Enter.
1=Add 2=Change 4=Delete 8=Usage 9=Library 13=History

Opt Device  Type  Description
-----
 8 TAP04    3590  3590 in the 5100 MTX Tape Library
 8 TAP05    3590  3590 in the 5100 MTX Tape Library

Selection or command
====>

F3=Exit  F4=Prompt  F5=Refresh  F6=Auto Config.  F9=Retrieve
F11=View 2  F12=Cancel  F15=Status
    
```

- Select **Option 2** from the Work with Tape Usage panel. This prompts the Change Tape Usage ([CHGTAPUSG](#)) command, which defines the range of volumes allowed.

```

Work with Tape Usage
-----
Device:  TAP04
Type options, press Enter.
2=Change 8=Volumes

-----Tape Pool-----
Opt Density  R/W  Beginning Ending Error
-----
 2 *FMT3590  R  *BEGIN  *END  *IGNORE
 2 *FMT3590E R/W  *BEGIN  *END  *IGNORE

Selection or command
====>

F3=Exit  F4=Prompt  F9=Retrieve  F11=View 2  F12=Cancel
(c) Copyright LXI Corp. 1985, 2006
    
```

- Change the beginning and ending range to include the entire range of volumes allowed in the tape library (even though the entire range may not be in the library). Change the Volume range error to ***REJECT** and press **Enter**.

```

Change Tape Usage (CHGTAPUSG)
-----
Type choices, press Enter.
Device name . . . . . TAP04      Name, *ANY
Tape Density . . . . . *FMT3590E  *DEVTYPE, *QIC120, 10000...
Initialize:
Format . . . . . 0NNNNN         Character value, *SAME
Number . . . . . 000000         Character value, *SAME
Allow format change. . *YES      *SAME, *NO, *YES
Range:
Beginning . . . . . 000000       Character value, *SAME...
Ending . . . . . 009999         Character value, *SAME, *END
Volume range error . . *REJECT   *SAME, *IGNORE, *REJECT
Owner . . . . . *ANY           Character value, *SAME...
+ for more values _____

Selection or command
====>

F3=Exit  F4=Prompt  F5=Refresh  F12=Cancel  F13=How to use this display
F24=More keys
    
```

- The volume range is used to select volumes for the tape library. Any volume in the device that is not within range is rejected from the device and replaced with a volume that is within the range. Press **Enter** twice to exit the Work with Tape Device panel.

```

Work with Tape Usage

Device:  TAP04

Type options, press Enter.
  2=Change  8=Volumes

-----Tape Pool-----
Opt Density  R/W  Beginning Ending Error
- *FMT3590   R   *BEGIN   *END   *IGNORE
- *FMT3590E R/W  000000   009999 *REJECT

Bottom

Selection or command
====>

F3=Exit  F4=Prompt  F9=Retrieve  F11=View 2  F12=Cancel
(c) Copyright LXI Corp. 1985, 2006

```

- To work with the volumes in a tape library, prompt the Work with Tape Library ([WRKTAPLIB](#)) command from a command line. Enter the name of the library device and press **Enter**. This displays the Work with Tape Library panel.

```

Work with Tape Library (WRKTAPLIB)

Type choices, press Enter.

Library device . . . . . ATL01  Name
Volume Status . . . . . *ALL    *ALL, *ACT, *ERR, *GEN...
System name . . . . . *ALL    Name, *LCL, *ALL
Output . . . . . *          *, *PRINT, *OUTFILE

Bottom

F3=Exit F4=Prompt F5=Refresh F12=Cancel F13=How to use this display
F24=More keys

```

- To synchronize the tape library volumes with the MMS/*tms* database, press **F16**. This prompts the Update Tape Library ([UPDTAPLIB](#)) command.

```

Work with Tape Library

Position to . . . . . _____ Volume identifier
Library . . . . . : ATL01

Type options, press Enter.
  4=Eject  5=Work with  8=Data  10=Initialize 11=Display 13=Dump
 14=Duplicate 15=Check

Opt Volume Date      Time      Status -----Text-----
- 001827 09/11/04  20:22:41 *SCR  LXI Daily  - Production - D
- 001112 09/16/04  08:04:18 *SCR  LXI Daily  - Production - D
- 003362 09/17/04  20:32:31 *SCR  LXI Daily  - Production - D

Bottom

Selection or command
====>

F3=Exit  F4=Prompt  F5=Refresh  F9=Retrieve  F10=View 4  F11=View 2
F12=Cancel  F15=Eject  F16=Update
(c) Copyright LXI Corp. 1985, 2006

```

10. Pressing **Enter** synchronizes the MTX tape library with the MMS/*tms* database on the local system.

```

Update Tape Library (UPDTAPLIB)

Type choices, press Enter.

Library device . . . . . ATL01      Name
Remote library device . . . . . *NONE  Name, *NONE, *ALL
System. . . . . _____      Name
      + for more values _____

Bottom
F3=Exit F4=Prompt F5=Refresh F12=Cancel F13=How to use this display
F24=More keys
    
```

11. When complete, press **F5** from the Work with Tape Library panel to update the panel list.

```

Work with Tape Library

Position to . . . . . _____      Volume identifier
Library . . . . . : ATL01

Type options, press Enter.
4=Eject 5=Work with 8=Data 10=Initialize 11=Display 13=Dump
14=Duplicate 15=Check

Opt Volume Date      Time      Status -----Text-----
- 001827 09/11/04    20:22:41 *SCR  LXI Daily   - Production - D
- 003827 09/16/04    08:04:18 *SCR  LXI Daily   - Production - D
- 006615 09/17/04    20:32:31 *SCR  LXI Daily   - Production - D

Bottom
Selection or command
====>

F3=Exit F4=Prompt F5=Refresh F9=Retrieve F10=View 4 F11=View 2
F12=Cancel F15=Eject F16=Update
(c) Copyright LXI Corp. 1985, 2006
    
```

Synchronizing the MTX Tape Library

The Update Tape Library ([UPDTAPLIB](#)) command should be run when:

- the tape library is powered off/on
- the tape library is being audited
- tapes are added outside of MMS/*tms*
- tapes are removed outside of MMS/*tms*

Restricted State Considerations

When using an MTX tape library in restricted state, special considerations must be observed. Since the MTX tape library does not function as a random-access library in restricted state, it must be “primed” with a list of volumes prior to use. Failure to “prime” the library prevents it from being used in restricted state. Perform the following steps, in the order listed, to ensure successful tape library usage in restricted state.

- Prompt the Change Tape Library ([CHGTAPLIB](#)) command. Enter a status of ***SEQ**, the tape device being used, a Job Label and the number of volumes to use while in restricted state. This changes the library to sequential mode. Volumes are automatically mounted as their needed. Volumes added with the Add Volume ([ADDVOL](#)) command are not selected.
- Put the system in restricted state and perform all tape functions. When complete, start all subsystems, including the tape library subsystems **ATLCONTROS** and **ATLBATCHS**.
- Issue the Change Tape Library ([CHGTAPLIB](#)) command with a status of ***RANDOM**. This changes the tape library to random or library mode.

Updating the MTX Server

If ***ANY** is specified in the Device Definition **USAGE** parameter, the Update Library Server ([UPDLIBSVR](#)) command must be run to update the server with the latest volume information. As volumes expire, they should become available for use by other systems using the library. To update the server with the current volume status, perform the following:

```
UPDLIBSVR DEV(library-device)
```

This function should be scheduled in a job scheduler and run daily.

STK - Direct Attach Configuration

- From a command line, type [WRKTAPDEV](#) and press **Enter**. Press **F6** to automatically configure all devices defined to OS/400. When the message “*Auto-configuration is complete.*” is displayed, press **F5** to view all configured devices.

```

Work with Tape Device
-----
Position to . . . . . Starting characters
Type options, press Enter.
    1=Add 2=Change 4=Delete 8=Usage 9=Library 13=History
Opt Device  Type  Description
-----
                                         Bottom
Selection or command
====>

F3=Exit   F4=Prompt   F5=Refresh   F6=Auto Config.   F9=Retrieve
F11=View 2 F12=Cancel  F15=Status
    
```

- To specify optional tape pools, use **Option 8** on the Device Definitions. This displays the tape usage information.

```

Work with Tape Device
-----
Position to . . . . . Starting characters
Type options, press Enter.
    1=Add 2=Change 4=Delete 8=Usage 9=Library 13=History
Opt Device  Type  Description
-----
 8 TAP04     3590  3590 in the 9710 STK Tape Library
 8 TAP05     3590  3590 in the 9710 STK Tape Library
                                         Bottom
Selection or command
====>

F3=Exit   F4=Prompt   F5=Refresh   F6=Auto Config.   F9=Retrieve
F11=View 2 F12=Cancel  F15=Status
    
```

- Select **Option 2** from the Work with Tape Usage panel. This prompts the Change Tape Usage ([CHGTAPUSG](#)) command, which defines the range of volumes allowed.

```

Work with Tape Usage
-----
Device:  TAP04
Type options, press Enter.
    2=Change  8=Volumes
-----Tape Pool-----
Opt Density  R/W  Beginning Ending Error
-----
 2 *FMT3590   R    *BEGIN   *END   *IGNORE
 2 *FMT3590E  R/W  *BEGIN   *END   *IGNORE
                                         Bottom
Selection or command
====>

F3=Exit   F4=Prompt   F9=Retrieve   F11=View 2   F12=Cancel
(c) Copyright LXI Corp. 1985, 2006
    
```

- If needed, change the beginning and ending range to include the entire range of volumes allowed in the tape library (even though the entire range may not be in the library). Change the Volume range error to ***REJECT** and press **Enter**.

```

Change Tape Usage (CHGTAPUSG)

Type choices, press Enter.
Device name . . . . . TAP04          Name, *ANY
Tape Density . . . . . *FMT3590E     *DEVTYPE, *QIC120, 10000...
Initialize:
  Format . . . . . 0NNNNN           Character value, *SAME
  Number . . . . . 000000          Character value, *SAME
  Allow format change. . *YES       *SAME, *NO, *YES
Range:
  Beginning . . . . . 000000       Character value, *SAME...
  Ending . . . . . 009999         Character value, *SAME, *END
  Volume range error . . *REJECT    *SAME, *IGNORE, *REJECT
Owner . . . . . *ANY              Character value, *SAME...
  + for more values _____

Bottom
F3=Exit F4=Prompt F5=Refresh F12=Cancel F13=How to use this display
F24=More keys

```

- The volume range is used to select volumes for the tape library. Any volume in the device that is not within range is rejected from the device and replaced with a volume that is within the range. Press **Enter** twice to exit the Work with Tape Device panel.

```

Work with Tape Usage

Device: TAP04

Type options, press Enter.
  2=Change  8=Volumes

-----Tape Pool-----
Opt Density  R/W  Beginning Ending Error
- *FMT3590  R   *BEGIN  *END  *IGNORE
- *FMT3590E R/W  000000  009999 *REJECT

Bottom

Selection or command
====>

F3=Exit  F4=Prompt  F9=Retrieve  F11=View 2  F12=Cancel
(c) Copyright LXI Corp. 1985, 2006

```

- To work with the volumes in a tape library, prompt the Work with Tape Library ([WRKTAPLIB](#)) command from a command line. Enter the name of the library device and press **Enter**. This displays the Work with Tape Library panel.

```

Work with Tape Library (WRKTAPLIB)

Type choices, press Enter.
Library device . . . . . RML9710    Name
Volume Status . . . . . *ALL        *ALL, *ACT, *ERR, *GEN...
System name . . . . . *ALL         Name, *LCL, *ALL
Output. . . . . *                  *, *PRINT, *OUTFILE

Bottom
F3=Exit F4=Prompt F5=Refresh F12=Cancel F13=How to use this display
F24=More keys

```

7. This panel displays all volumes in the specified tape library. Volumes can be initialized, scratched, viewed or ejected.

```

Work with Tape Library
Position to . . . . . _____ Volume identifier
Library . . . . . : RML9710

Type options, press Enter.
 4=Eject  5=Work with  8=Data  10=Initialize 11=Display 13=Dump
14=Duplicate 15=Check

Opt Volume Date      Time      Status -----Text-----
- 004536 09/11/04    20:22:41 *SCR  LXI Daily   - Production - D
- 006253 09/16/04    08:04:18 *SCR  LXI Daily   - Production - D
- 007760 09/17/04    20:32:31 *SCR  LXI Daily   - Production - D

                                                    Bottom
Selection or command
====>

F3=Exit  F4=Prompt  F5=Refresh  F9=Retrieve  F10=View 4  F11=View 2
F12=Cancel  F15=Eject  F16=Update
(c) Copyright LXI Corp. 1985, 2006

```

Restricted State Considerations - STK - Direct Attach

When using an StorageTek direct attach tape library in restricted state, special considerations must be observed. Since the StorageTek direct attach tape library does not function as a random-access library in restricted state, it must be “primed” with a list of volumes prior to use. Failure to “prime” the library prevents it from being used in restricted state. Perform the following steps, in the order listed, to ensure successful tape library usage in restricted state.

1. Put the system in restricted state.
2. Prompt the Change Tape Library ([CHGTAPLIB](#)) command. Enter a status of ***SEQ**, the tape device being used, a Job Label and the number of volumes to use while in restricted state. This changes the library to sequential mode. Volumes are automatically mounted as their used. Volumes added with the Add Volume ([ADDVOL](#)) command are not selected.
3. Perform all tape functions.
4. Issue the Change Tape Library ([CHGTAPLIB](#)) command with a status of ***RANDOM**. This changes the library to random or library mode.
5. When complete, start all subsystems, including the tape library subsystem **RMLSDASBS**.

STK - Server Attach Configuration

- From a command line, type [WRKTAPDEV](#) and press **Enter**. Press **F6** to automatically configure all devices defined to OS/400. When the message “*Auto-configuration is complete.*” is displayed, press **F5** to view all configured devices.

```

Work with Tape Device
-----
Position to . . . . . Starting characters
Type options, press Enter.
1=Add 2=Change 4=Delete 8=Usage 9=Library 13=History
Opt Device Type Description
-----
Selection or command
====>
-----
F3=Exit F4=Prompt F5=Refresh F6=Auto Config. F9=Retrieve
F11=View 2 F12=Cancel F15=Status
  
```

- To specify optional tape pools, use **Option 8** on the Device Definitions. This displays the tape usage information.

```

Work with Tape Device
-----
Position to . . . . . Starting characters
Type options, press Enter.
1=Add 2=Change 4=Delete 8=Usage 9=Library 13=History
Opt Device Type Description
-----
8 TAP04 3590 3590 in the 9710 STK Tape Library
8 TAP05 3590 3590 in the 9710 STK Tape Library
-----
Selection or command
====>
-----
F3=Exit F4=Prompt F5=Refresh F6=Auto Config. F9=Retrieve
F11=View 2 F12=Cancel F15=Status
  
```

- Select **Option 2** from the Work with Tape Usage panel. This prompts the Change Tape Usage ([CHGTAPUSG](#)) command, which defines the range of volumes allowed.

```

Work with Tape Usage
-----
Device: TAP04
Type options, press Enter.
2=Change 8=Volumes
-----Tape Pool-----
Opt Density R/W Beginning Ending Error
- *FMT3590 R *BEGIN *END *IGNORE
2 *FMT3590E R/W *BEGIN *END *IGNORE
-----
Selection or command
====>
-----
F3=Exit F4=Prompt F9=Retrieve F11=View 2 F12=Cancel
(c) Copyright LXI Corp. 1985, 2006
  
```

- Change the beginning and ending range to include the entire range of volumes allowed in the tape library (even though the entire range may not be in the library). Change the Volume range error to ***REJECT** and press **Enter**.

```

Change Tape Usage (CHGTAPUSG)

Type choices, press Enter.
Device name . . . . . TAP04          Name, *ANY
Tape Density . . . . . *FMT3590E     *DEVTYPE, *QIC120, 10000...
Initialize:
Format . . . . . 0NNNNN             Character value, *SAME
Number . . . . . 000000             Character value, *SAME
Allow format change. . *YES          *SAME, *NO, *YES
Range:
Beginning . . . . . 000000          Character value, *SAME...
Ending . . . . . 009999            Character value, *SAME, *END
Volume range error . . *REJECT      *SAME, *IGNORE, *REJECT
Owner . . . . . *ANY                Character value, *SAME...
+ for more values _____

Bottom
F3=Exit F4=Prompt F5=Refresh F12=Cancel F13=How to use this display
F24=More keys
    
```

- The volume range is used to select volumes for the tape library. Any volume in the device that is not within range is rejected from the device and replaced with a volume that is within the range. Press **Enter** twice to exit the Work with Tape Device panel.

```

Work with Tape Usage

Device: TAP04

Type options, press Enter.
2=Change 8=Volumes

-----Tape Pool-----
Opt Density R/W Beginning Ending Error
_ *FMT3590 R *BEGIN *END *IGNORE
_ *FMT3590E R/W 000000 009999 *REJECT

Bottom
Selection or command
====>

F3=Exit F4=Prompt F9=Retrieve F11=View 2 F12=Cancel
(c) Copyright LXT Corp. 1985, 2006
    
```

- To work with the volumes in a tape library, prompt the Work with Tape Library [\(WRKTAPLIB\)](#) command from a command line. Enter the name of the library device and press **Enter**. This displays the Work with Tape Library panel.

```

Work with Tape Library (WRKTAPLIB)

Type choices, press Enter.
Library device . . . . . RML9710     Name
Volume Status . . . . . *ALL         *ALL, *ACT, *ERR, *GEN...
System name . . . . . *ALL          Name, *LCL, *ALL
Output . . . . . *                  *, *PRINT, *OUTFILE

Bottom
F3=Exit F4=Prompt F5=Refresh F12=Cancel F13=How to use this display
F24=More keys
    
```

- To synchronize the tape library volumes with the MMS/*tms* database, press **F16**. This prompts the Update Tape Library ([UPDTAPLIB](#)) command.

```

Work with Tape Library

Position to . . . . . _____ Volume identifier
Library . . . . . : RML9710

Type options, press Enter.
 4=Eject 5=Work with 8=Data 10=Initialize 11=Display 13=Dump
14=Duplicate 15=Check

Opt Volume Date      Time      Status -----Text-----
- 000928 09/11/04    20:22:41 *SCR  LXI Daily   - Production - D
- 003362 09/16/04    08:04:18 *SCR  LXI Daily   - Production - D
- 001019 09/17/04    20:32:31 *SCR  LXI Daily   - Production - D

                                                    Bottom

Selection or command
====>

F3=Exit  F4=Prompt  F5=Refresh  F9=Retrieve  F10=View 4  F11=View 2
F12=Cancel  F15=Eject  F16=Update
(c) Copyright LXI Corp. 1985, 2006

```

- Pressing **Enter** synchronizes the STK tape library with the MMS/*tms* database on the local system.

```

Update Tape Library (UPDTAPLIB)

Type choices, press Enter.

Library device . . . . . RML9710      Name
Remote library device . . . . . *NONE      Name, *NONE, *ALL
System . . . . . _____      Name
      + for more values _____

                                                    Bottom

F3=Exit  F4=Prompt  F5=Refresh  F12=Cancel  F13=How to use this display
F24=More keys

```

- When complete, press **F5** from the Work with Tape Library panel to update the panel list.

```

Work with Tape Library

Position to . . . . . _____ Volume identifier
Library . . . . . : RML9710

Type options, press Enter.
 4=Eject 5=Work with 8=Data 10=Initialize 11=Display 13=Dump
14=Duplicate 15=Check

Opt Volume Date      Time      Status -----Text-----
- 001827 09/11/04    20:22:41 *SCR  LXI Daily   - Production - D
- 003827 09/16/04    08:04:18 *SCR  LXI Daily   - Production - D
- 006615 09/17/04    20:32:31 *SCR  LXI Daily   - Production - D

                                                    Bottom

Selection or command
====>

F3=Exit  F4=Prompt  F5=Refresh  F9=Retrieve  F10=View 4  F11=View 2
F12=Cancel  F15=Eject  F16=Update
(c) Copyright LXI Corp. 1985, 2006

```

Synchronizing the STK- Server Attach

The Update Tape Library ([UPDTAPLIB](#)) command should be run when:

- the tape library is powered off/on
- the tape library is being audited
- tapes are added outside of MMS/*tms*
- tapes are removed outside of MMS/*tms*

The tape library remains synchronized with the MMS/*tms* database as long as the MMS/*tms* Enter Volume ([ENTVOL](#)) command is used to add/enter volumes into the library and the MMS/*tms* Eject Volume ([EJTVOL](#)) command is used to remove volumes from the library. If volumes are added or removed from the library without using these commands, the library needs to be synchronized using the Update Tape Library ([UPDTAPLIB](#)) command. This command must be run on all iSeries in the MMS/*tms* network and can be scheduled to run in a job scheduler.

STK Library Station Configuration

- From a command line, type [WRKTAPDEV](#) and press **Enter**. Press **F6** to automatically configure all devices defined to OS/400. When the message “*Auto-configuration is complete.*” is displayed, press **F5** to view all configured devices.

```

Work with Tape Device
Position to . . . . . Starting characters
Type options, press Enter.
  1=Add  2=Change  4=Delete  8=Usage  9=Library  13=History
Opt Device  Type  Description
-----
Selection or command
====>

F3=Exit  F4=Prompt  F5=Refresh  F6=Auto Config.  F9=Retrieve
F11=View 2  F12=Cancel  F15=Status

```

- To specify optional tape pools, use **Option 8** on the Device Definitions. This displays the tape usage information.

```

Work with Tape Device
Position to . . . . . Starting characters
Type options, press Enter.
  1=Add  2=Change  4=Delete  8=Usage  9=Library  13=History
Opt Device  Type  Description
-----
  8 TAP04    3590  3590 in the STK Library Station
  8 TAP05    3590  3590 in the STK Library Station
Selection or command
====>

F3=Exit  F4=Prompt  F5=Refresh  F6=Auto Config.  F9=Retrieve
F11=View 2  F12=Cancel  F15=Status

```

- Select **Option 2** from the Work with Tape Usage panel. This prompts the Change Tape Usage ([CHGTAPUSG](#)) command, which defines the range of volumes allowed.

```

Work with Tape Usage
Device:  TAP04
Type options, press Enter.
  2=Change  8=Volumes
-----Tape Pool-----
Opt Density  R/W  Beginning Ending Error
  2 *FMT3590  R  *BEGIN  *END  *IGNORE
  2 *FMT3590E R/W *BEGIN  *END  *IGNORE
Selection or command
====>

F3=Exit  F4=Prompt  F9=Retrieve  F11=View 2  F12=Cancel
(c) Copyright LXI Corp. 1985, 2006

```

- Change the beginning and ending range to include the entire range of volumes allowed in the tape library (even though the entire range may not be in the library). Change the Volume range error to ***REJECT** and press **Enter**.

```

Change Tape Usage (CHGTAPUSG)

Type choices, press Enter.

Device name . . . . . TAP04          Name, *ANY
Tape Density . . . . . *FMT3590E    *DEVTYPE, *QIC120, 10000...
Initialize:
  Format . . . . . 0NNNNN           Character value, *SAME
  Number . . . . . 000000          Character value, *SAME
  Allow format change. . *YES       *SAME, *NO, *YES
Range:
  Beginning . . . . . 000000        Character value, *SAME...
  Ending . . . . . 009999          Character value, *SAME, *END
  Volume range error . . *REJECT    *SAME, *IGNORE, *REJECT
  Owner . . . . . *ANY             Character value, *SAME...
  + for more values _____

Bottom
F3=Exit F4=Prompt F5=Refresh F12=Cancel F13=How to use this display
F24=More keys
    
```

- The volume range is used to select volumes for the tape library. Any volume in the device that is not within range is rejected from the device and replaced with a volume that is within the range. Press **Enter** twice to exit the Work with Tape Device panel.

```

Work with Tape Usage

Device: TAP04

Type options, press Enter.
  2=Change  8=Volumes

-----Tape Pool-----
Opt Density  R/W  Beginning Ending Error
- *FMT3590  R   *BEGIN  *END  *IGNORE
- *FMT3590E R/W  000000  009999 *REJECT

Bottom

Selection or command
====>

F3=Exit  F4=Prompt  F9=Retrieve  F11=View 2  F12=Cancel
(c) Copyright LXI Corp. 1985, 2006
    
```

- To work with the volumes in a tape library, prompt the Work with Tape Library [\(WRKTAPLIB\)](#) command from a command line. Enter the name of the library device and press **Enter**. This displays the Work with Tape Library panel.

```

Work with Tape Library (WRKTAPLIB)

Type choices, press Enter.

Library device . . . . . RML01      Name
Volume Status . . . . . *ALL       *ALL, *ACT, *ERR, *GEN...
System name . . . . . *ALL         Name, *LCL, *ALL
Output . . . . . *                 *, *PRINT, *OUTFILE

Bottom

F3=Exit F4=Prompt F5=Refresh F12=Cancel F13=How to use this display
F24=More keys
    
```

7. To synchronize the tape library volumes with the MMS/*tms* database, press **F16**. This prompts the Update Tape Library ([UPDTAPLIB](#)) command.

```

Work with Tape Library

Position to . . . . . _____ Volume identifier
Library . . . . . : RML01

Type options, press Enter.
 4=Eject 5=Work with 8=Data 10=Initialize 11=Display 13=Dump
14=Duplicate 15=Check

Opt Volume Date      Time      Status -----Text-----
- 001564 09/11/04    20:22:41 *SCR LXI Daily - Production - D
- 001983 09/16/04    08:04:18 *SCR LXI Daily - Production - D
- 001881 09/17/04    20:32:31 *SCR LXI Daily - Production - D

                                                    Bottom

Selection or command
====>

F3=Exit F4=Prompt F5=Refresh F9=Retrieve F10=View 4 F11=View 2
F12=Cancel F15=Eject F16=Update
(c) Copyright LXI Corp. 1985, 2006

```

8. Pressing **Enter** synchronizes the STK tape library with the MMS/*tms* database on the local system.

```

Update Tape Library (UPDTAPLIB)

Type choices, press Enter.

Library device . . . . . RML01      Name
Remote library device . . . . . *NONE  Name, *NONE, *ALL
System . . . . . _____      Name
+ for more values _____

                                                    Bottom

F3=Exit F4=Prompt F5=Refresh F12=Cancel F13=How to use this display
F24=More keys

```

9. When complete, press **F5** from the Work with Tape Library panel to update the panel list.

```

Work with Tape Library

Position to . . . . . _____ Volume identifier
Library . . . . . : RML01

Type options, press Enter.
 4=Eject 5=Work with 8=Data 10=Initialize 11=Display 13=Dump
14=Duplicate 15=Check

Opt Volume Date      Time      Status -----Text-----
- 001827 09/11/04    20:22:41 *SCR LXI Daily - Production - D
- 003827 09/16/04    08:04:18 *SCR LXI Daily - Production - D
- 006615 09/17/04    20:32:31 *SCR LXI Daily - Production - D

                                                    Bottom

Selection or command
====>

F3=Exit F4=Prompt F5=Refresh F9=Retrieve F10=View 4 F11=View 2
F12=Cancel F15=Eject F16=Update
(c) Copyright LXI Corp. 1985, 2006

```

Synchronizing the Library Station Attach STK

The Update Tape Library ([UPDTAPLIB](#)) command should be run when:

- the tape library is powered off/on
- the tape library is being audited
- tapes are added outside of MMS/*tms*
- tapes are removed outside of MMS/*tms*

The tape library remains synchronized with the MMS/*tms* database as long as the MMS/*tms* Enter Volume ([ENTVOL](#)) command is used to add/enter volumes into the library and the MMS/*tms* Eject Volume ([EJTVOL](#)) command is used to remove volumes from the library. If volumes are added or removed from the library without using these commands, the library needs to be synchronized using the Update Tape Library ([UPDTAPLIB](#)) command. This command must be run on all iSeries in the MMS/*tms* network and can be scheduled to run in a job scheduler.

Chapter 15

Auditing MMS/tms

Tapes are initialized, Job Labels changed, volumes added, communication links changed, devices deleted and on and on. Normal data center activity generates massive amounts of changes. In this hectic environment, it is hard to tell who did what and when. Auditing provides the answers to these questions. Additions, changes and deletions need to be tracked to ensure that unauthorized use does not occur.

MMS/*tms* provides an audit facility that records all MMS/*tms* changes to the IBM system history log. The amount of information available is based on the function being performed. The information recorded can be viewed without having to sort through other non-MMS/*tms* data. Since the IBM history log is used, every record contains the date/time and job/user/number that performed the function.

Additionally, MMS/*tms* provides the tools necessary to scan the history log for user specific data. Scanning the history log shows only the data requested, even if the scanned data resides in the second level text of the message.

This chapter discusses:

- Audit processing
- How to display MMS/*tms* messages
- How to scan the History Log

MMS/*tms* Audit Overview

When a MMS/*tms* function is used, its use is recorded in the IBM history log (QHST). The information available depends on the function performed. Changes to a volumes attributes, or changes to MMS/*tms* options, generate the most information. Regardless of the function, the message indicates the action performed and what the action was performed on.

Displaying LXI History Messages

To list all LXI audit messages, use **Option 3** from the MMS/*tms* Security Commands menu. This prompts the IBM Display Log (**DSPLOG**) command, which lists LXI product messages. All other messages are bypassed.

```

CMDSEC                               Security Commands                               System:  S1234567
-----
Select one of the following:
    1. Change Volume Security
    3. Display LXI Log Entries
    4. Scan History Log

Related Command Menus
    83. Security Commands

Commands
===> _____

F3=Exit  F4=Prompt  F9=Retrieve  F12=Cancel
(c) Copyright LXI Corp. 1985, 2006

Display History Log Contents

MMS/tms - Volume 000000 deleted.
MMS/tms - Job label "DAILY" added.
MMS/tms - Detached.
MMS/tms - Volume TPL007 deleted.
MMS/tms - Volume MMS124 deleted.
MMS/tms - Volume JK0123 deleted.
MMS/tms - Volume 902845 added.
MMS/tms - Volume ABC deleted.
MMS/tms - Attached.
MMS/tms - Job label "DAILY" deleted.
MMS/tms - Job label "TEST" added.
MMS/tms - Volume 902845 deleted.
MMS/tms - Detached.
MMS/tms - Attached.
MMS/tms - Detached.
LXI/tms - Attached.

Press Enter to continue.

More...

F3=Exit  F10=Display all  F12=Cancel

```

Scanning the History Log

The MMS/*tms* Scan History Log ([SCNLOG](#)) command searches the IBM History Log ([QHST](#)) for a specific character string. The scan log process searches the entire OS/400 message, including second level text, for the specified character string and if found, lists it along with all other matches. SCNLOG requires IBM Licensed Program 5716PW1.

Using the Scan Log Command

To scan the History Log for a user specified string, use **Option 4** from the MMS/*tms* Security Commands menu. This prompts the Scan Log ([SCNLOG](#)) command.

```
CMDSEC Security Commands System: C1224557
Select one of the following:
  1. Change Volume Security
  2. Display MMS/tms Log Entries
  3. Scan History Log
Related Command Menus
  82. Security Commands
Commands
===>
F3=Exit F4=Prompt F9=Retrieve F12=Cancel
(c) Copyright LXI Corp. 1985, 2006

Scan History Log (SCNLOG)
Type choices, press Enter.
Find 'string' . . . . .
Time period for scan output:
Starting date and time:
Beginning date . . . . . *CURRENT Date, *CURRENT, *BEGIN
Beginning time . . . . . *AVAIL Time, *AVAIL
Ending date and time:
Ending date . . . . . *CURRENT Date, *CURRENT, *END
Ending time . . . . . *AVAIL Time, *AVAIL
F3=Exit F4=Prompt F5=Refresh F10=Additional parameters F12=Cancel
F13=How to use this display F24=More keys
```

Using the Scan Log Command

If additional information is required, use **Option 5** to display the entry in the IBM History Log.

```
Scan Log
Type options, press Enter.
5=Display
Opt Date Time
5 10/23/04 21:01:08 8 objects saved from library BMS5.0P.
- 10/23/04 21:01:41 60 objects saved from library BMS5.0P.
- 10/23/04 21:03:17 54 objects saved from library CMS5.0.
- 10/23/04 21:03:18 6 objects saved from library COLLINS.
- 10/23/04 21:04:43 102 objects saved from library CONSOLE.
- 10/23/04 21:04:43 98 objects saved from library CONSOLE.H.
- 10/23/04 21:04:44 30 objects saved from library CON2.3C.
- 10/23/04 21:04:44 100 objects saved from library CON2.3P.
- 10/23/04 21:04:44 2 objects saved from library CON3.6P.
- 10/23/04 21:05:53 35 objects saved from library CPYSRCE.
- 10/23/04 21:05:53 8 objects saved from library CPYSRCE.
- 10/23/04 21:05:53 9 objects saved from library HFS$SRCE.
More...
Selection or command
===>
F3=Exit F4=Prompt F9=Retrieve F11=View 2 F12=Cancel
```

Chapter 16

MMS/tms Reports

The following is a list of all reports available from MMS/*tms*. The name of the report and the command(s) used to print them and the printer file are listed. All printer files, except the one used by the IBM **DSPLOG** command, reside in library **LXITMS400**.

| Report | Command | Printer File |
|----------------------------|---------------------|--|
| Communication Link | WRKCMNLNK | QTMSPR1 |
| Communication Link Details | DSPCMNLNK | QTMSPR1 |
| Compare Volume | CMPVOL | QTMSPR1 |
| Job Label | DSPJOBLBL/WRKJOBLBL | QTMSPR1 |
| Recovery | PRTRCYVOL | QTMSPR1 |
| Saved DLO | DSPSAVDLO/WRKSAVDLO | QTMSPR1 |
| Saved Links | DPSAVLNK/WRKSAVLNK | QTMSPR1 |
| Saved Object List | RSTSAVOBJ | QTMSPR1 |
| Saved Objects | DPSAVOBJ/WRKSAVOBJ | QTMSPR1 |
| Scan Log | SCNLOG | QTMSPR1 |
| Tape Devices | WRKTAPDEV | QTMSPR1 |
| Tape Library Volumes | WRKTAPLIB | QTMSPR1 |
| Tape Usage | WRKTAPUSG | QTMSPR1 |
| TMS Audit Log | DSPLOG | QTMSPR1 |
| Volume Data (Contents) | DSPVOLDTA | QTMSPR1 |
| Volume Information | DSPVOLINF | QTMSPR1 |
| Volume Label | PRTVOLLBL | QSYSCART QSYSQIC QSYSREEL QSYS8MM |
| Volumes | DSPVOL/WRKVOL | QTMSPR1 |
| Volumes | PRTVOLSTS | QTMSPR1 |

Accessing the Report Menu

To access the MMS/*tms* report menu, enter **Option 10** from the Tape menu.

```

Setup  Communications  Go  Help
-----
LXITMS                               Tape
Select one of the following:
  1. Work with Job label
  2. Work with Volume

 10. Reports

Related Command Menus
 80. Job Label Commands
 81. Saved Object Commands
 82. Security Commands
 83. Tape Commands
 84. Volume Commands

Selection or command
====>

F3=Exit  F4=Prompt  F9=Retrieve  F12=Cancel  F
(c) Copyright LXI Corp. 1985, 2006

Setup  AutoReport  Scheduler
-----
TMSRPT                               Reports                               System:  S1234567
Select one of the following:
  1. Display Job Label                               DSPJOBLBL
  2. Display Volume                                 DSPVOL
  3. Display Volume Data                             DSPVOLDTA
  4. Display Volume Information                       DSPVOLINF
  6. Print Volume Label                               PRTVOLLBL
  7. Print Volume Status                             PRTVOLSTS
  9. Work with Communication Links                   WRKCMNLNK
 10. Work with Tape Device                           WRKTAPDEV
 11. Work with Tape Usage                           WRKTAPUSG

Selection or command
====>

F3=Exit  F4=Prompt  F9=Retrieve  F12=Cancel
  
```

Printing Reports

To print a report, enter the desired option number from the Reports menu. This prompts the associated command for selection criteria, if required, and spools the output to the job's output queue or to the output queue specified in the printer file, if overridden. The reports can also be printed by prompting the commands (listed on the right-hand side) and specifying ***PRINT** for the **OUTPUT** parameter.

The report menu contains the more common MMS/*tms* reports available. Not all reports are available from the Report menu. To access other reports, prompt the desired command, specifying ***PRINT** for the **OUTPUT** parameter.

Changing Printer File Attributes

MMS/*tms* allows you to change the attributes of the printer device file. The attributes that can be changed include the device, device type, lines per page, lines per inch, characters per inch and output queue. The ability to change the MMS/*tms* printer file is based on the users authority to the IBM Change Printer File (**CHGPRTF**) command.

Changing Printer Attributes

To change the attributes of a MMS/*tms* printer file, select the Setup pull down menu from the Reports menu. Select **Option 1**, Printer Files. This lists the printer files available for change. Select **Option 2** for the printer file requiring modifications and change the parameters as needed. The changes remain with the printer file until changed again.

```
Setup  AutoReport  Scheduler
-----
: 1. Printer Files :      Reports
:.....:
Select one of the following:

1. Display Communication Link
2. Display Job Label
3. Display Volume
4. Display Volume Data
5. Display Volume Information

7. Print Recovery Volumes
8. Print Volume Label
9. Print Volume Status

11. Work with Communication Links
12. Work with Tape Devices

-----
QSECOFR      Work with Printer Files      System:  S10137AG
Type options, press Enter.
2=Change

Opt Object   Attribute   Text
- QSYSCART   PRTF       Tape Label - 1/2" Cartridge
2 QTMSPRT    PRTF       MMS/tms non-described printer file
- QSYSQIC    PRTF       Tape Label - 1/4" Cartridge
- QSYSREEL   PRTF       Tape Label - Reel
- QSYS8MM    PRTF       Tape Label - 8mm

-----
Change Printer File (CHGPRTF)
Type choices, press Enter.

File . . . . . QTMSPRT  Name, generic*, *ALL
Library . . . . . LXITMS400  Name, *LIBL, *ALL...
Device:
Printer . . . . . *JOB      Name, *SAME, *JOB...
Printer device type . . . . *SCS      *SAME, *SCS...
Page size:
Length--lines per page . . 66         .001-255.000, *SAME
Width--positions per line  132        .001-378.000, *SAME
Measurement method . . . . *ROWCOL    *SAME, *ROWCOL, *UOM
Lines per inch . . . . . 6           *SAME, 6, 3, 4, 7.5...
Characters per inch . . . . 10         *SAME, 10, 5, 12...
Overflow line number . . . . 60         1-255, *SAME
Record format level check . *NO        *SAME, *YES, *NO
Text 'description' . . . . . 'MMS/tms non-described printer'

-----
Bottom
F3=Exit F4=Prompt F5=Refresh F10=Additional parameters F12=Cancel
F13=How to use this display F24=More keys
```

Scheduling Reports

MMS/*tms* provides the ability to automatically print the Volume Report. This is accomplished through the job scheduler interface. The product, as shipped, interfaces with the LXI job scheduler. If the LXI scheduler is not installed, the IBM OS/400 job scheduler is used.

Adding Scheduled Reports

To schedule the Volume Report, select **AutoReport** from the Reports pull-down menu. Select the type of volumes to print on the volume report and press **Enter**. This prompts the Add Job Schedule Entry command. Enter the desired run time information and press **Enter**. This schedules the report to run as specified. More than one report can be scheduled and the same report can be scheduled multiple times.

Note: *Auto-reports contain only the last 24-hours information.*

```

Setup  AutoReport  Scheduler
-----
TMSRPT : 1. All Volumes      : ports
        : 2. Active Volumes  :
Select  : 3. Error Volumes   :
        : 4. Generation Volumes :
1. : 5. Recovery Volumes   :
2. : 6. Scratch Volumes    :
3. : .....
4. Display Volume Data
5. Display Volume Information

7. Print Recovery Volumes
8. Print Volume Label
9. Print Volume Status

10. Work with Communication Links
11. Work with Tape Device

Selection or command
===>

F3=Exit  F4=Prompt  F9=Retrieve  F12=Cancel

Add Job Schedule Entry (ADDJOBSCDE)
Type choices, press Enter.
Job name . . . . . LXITMS_ALL Name, *JOBID
Frequency . . . . . *CURRENT *ONCE, *WEEKLY, *MONTHLY
Schedule date, or . . . . . *CURRENT Date, *CURRENT...
Schedule day . . . . . *NONE *NONE, *ALL, *MON...
+ for more values
Schedule time . . . . . *CURRENT Time, *CURRENT

Bottom
F3=Exit F4=Prompt F5=Refresh F10=Additional parameters F12=Cancel
F13=How to use this display F24=More keys
    
```

Changing Scheduled Reports

To change a scheduled report, select Scheduler from the Reports pull-down menu. Select **Option 1, Work with....** This lists the MMS/*tms* scheduled reports available for change.

Deleting Scheduled Reports

To delete a scheduled report, select Scheduler from the Reports pull-down menu. Select **Option 1, Work with....** This lists the MMS/*tms* scheduled reports available for deletion.

Communication Link Report

The Work with Communication Links ([WRKCMNLNK](#)) command creates the Communication Links report. The report shows all communication links defined to MMS/*tms*.

```

                                     Communication Links
                                     Page      1
                                     S1234567 10/01/05 13:43:55

Remote  Link  Status
S1122334 *TCP  *ACTIVE
S1122445 *CPIC *ACTIVE
S1122556 *TCP  *ACTIVE

* * * * * (c) Copyright LXI Corp. 1985, 2006 * * * * *
```

Communication Link Details Report

The Display Communication Link ([DSPCMNLNK](#)) command creates the Communication Link Details report. The report shows the configuration parameters defined for a specific location.

```
Communication Link Details                                     Page 1
S1234567 10/01/05 13:43:55

Remote location name . . . . : S1122334
System name . . . . . : S1122334
Status . . . . . : *ACTIVE
Link type . . . . . : *TCP
Platform . . . . . : *OS400
Internet address . . . . . : 1.2.34.567
Remote port number . . . . : 1300
Host name . . . . . : S1122334
```

* * * * * (c) Copyright LXI Corp. 1985, 2006 * * * * *

Compare Volume Report

The Compare Volume ([CMPVOL](#)) command creates the Compare Volume report. The report shows all volume database discrepancies between the local (**source**) and remote (**target**) systems. If a field discrepancy is found, the volume, the field name and the values from the local and remote system are printed.

```

                                Compare Volume
                                S1234567 10/05/05 11:55:41
                                Remote . . . : S1122334
                                -----Local-----
Volume  Field      Value
APCBU1  Loc. Name      *DFTLOC
BLK001  Loc. Name      Default Loc.
BLK002  Loc. Name      Default Loc.
BLK003  Loc. Name      *DFTLOC
BLK004  Loc. Name      *DFTLOC
CMS257  Loc. DTS       1040919180636
CMS257  Rtn Date       0000000
CMS258  Loc. DTS       1040919180636
CMS258  Rtn Date       0000000
C00001  Loc. Name      01-LXI#001
C00006  Loc. Name      01-LXI#001
C00007  Loc. Name      01-LXI#001
C00013  Loc. Name      01-LXI#001
C00014  Loc. Name      01-LXI#001
                                -----Remote-----
Volume  Value
APCBU1
BLK001
BLK002
BLK003
BLK004
CMS257  1040923074013
CMS257  0000000
CMS258  1040923074013
CMS258  0000000
C00001
C00006
C00007
C00013
C00014
                                * * * * * (c) Copyright LXI Corp. 1985, 2006 * * * * *

```

Job Label Report

The Display Job Label ([DSPJOBLBL](#)) or Work with Job Label ([WRKJOBLBL](#)) command create the Job Label report. The report shows all Job Labels defined to MMS/*tms*. The report shows the retention in days and generations specified for each job.

```

                                         Job Labels
                                         Page      1
                                         S1234567 10/02/05 08:40:34

Job Label. . . . . : *DFT
Referenced Job Label . . . . : *NONE
Retention:
  Generations. . . . . : 0
  Days . . . . . : 5
Text . . . . . : Default Job Label
Tape pool:
  Beginning. . . . . : *DEV
  Ending . . . . . : *DEV
  Last used. . . . . : 001000
  Usage. . . . . : *ANY
  Error. . . . . : *DEV
Retrieval level:
  DLO. . . . . : *NO
  Domino . . . . . : *YES
  IFS. . . . . : *NO
  Objects. . . . . : *LIB
  Save file. . . . . : *NO
Volume label . . . . . : *NO
```

* * * * * (c) Copyright LXI Corp. 1985, 2006 * * * * *

Recovery Report by Job Label

The Print Recovery Volumes ([PRTRCYVOL](#)) command creates two different reports. The Volumes for Recovery report shows the volumes used for up to 300 Job Labels. The purpose of the report is to provide a list of the volumes available for recovery. The number of saves to show per Job Label can be selected in the command. This eliminates volumes from prior years showing on the report. Report information includes the volumes, volume sequence, save date/time, status, expiration date, Job Label, location, container/slot return date and text.

```

                                Volumes for Recovery                                Page      1
                                S10137AG 02/26/05 11:08:12

Job Label . . . : *DFT
Generations . . : 0
Volumes Seq. Date      Time      Status Expires  Location Ctn/Slt Returns Text
TST001  1 01/23/05 13:18:31 *SCR 01/23/05 *DFTLOC *NONE 00/00/00 Default Job
TST900  1 02/24/05 10:47:23 *ACT 05/25/05 OS      *NONE 05/25/05 Default Job

Job Label . . . : DAILY
Generations . . : 4
Volumes Seq. Date      Time      Status Expires  Location Ctn/Slt Returns Text
800100  1 01/22/05 20:32:31 *GEN 01/29/05 *DFTLOC *NONE 00/00/00 Daily Backup
800107  1 01/21/05 20:38:05 *GEN 01/28/05 OS      *NONE 01/28/05 Daily Backup
800125  1 01/20/05 20:43:18 *GEN 01/27/05 OS      *NONE 01/27/05 Daily Backup
800163  1 01/19/05 20:44:41 *GEN 01/26/05 OS      *NONE 01/26/05 Daily Backup
800104  1 01/16/05 20:46:36 *SCR 01/25/05 OS      *NONE 01/25/05 Daily Backup

Job Label . . . : WEEKLY
Generations . . : 52
Volumes Seq. Date      Time      Status Expires  Location Ctn/Slt Returns Text
800100  1 01/26/05 21:46:22 *GEN 01/26/06 *DFTLOC *NONE 00/00/00 Weekly Backup
800107  2 01/26/05 20:23:19 *GEN 01/26/06 *DFTLOC *NONE 00/00/00 Weekly Backup
800125  1 01/19/05 21:18:43 *GEN 01/19/06 OS      *NONE 01/19/06 Weekly Backup
800163  2 01/19/05 20:07:09 *GEN 01/19/06 OS      *NONE 01/19/06 Weekly Backup
800104  1 01/12/05 21:39:51 *GEN 01/12/06 OS      *NONE 01/12/06 Weekly Backup
800163  2 01/12/05 20:12:36 *GEN 01/12/06 OS      *NONE 01/12/06 Weekly Backup

* * * * * (c) Copyright LXI Corp. 1985, 2006 * * * * *
```

Recovery Report by Library

The Print Recovery Volumes ([PRTRCYVOL](#)) command creates two different reports. The Library Recovery Status report shows the tapes required to recover the specified library. All tapes associated with the last save of a library are shown. Information includes the save command, sequence, media files and save format. If a save date/time discrepancy exists between the MMS/*tms* database and OS/400, the conflicting save date/times are shown.

```

                                Library Recovery Status
                                S1234567 02/26/05 11:08:12
                                Page      1
Library  Command  Volume  Sequence  Date      Time      Number Total  Format Date Time
APPGLIB  SAVLIB   350123    4      05/13/05  20:18:37    1      1      S
          SAVCHGOBJ 350220    57      06/03/05  23:12:56    1      1      S
APFILLIB SAVLIB   350123    5      05/13/05  20:22:45    1      1      S
          SAVCHGOBJ 350220    58      06/03/05  23:14:09    1      1      S
ARPGMLIB SAVLIB   350123    6      05/13/05  20:26:39    1      1      S
          SAVCHGOBJ 350220    59      06/03/05  23:16:22    1      1      S
ARFILLIB SAVLIB   350123    7      05/13/05  20:32:11    1      1      S
          SAVCHGOBJ 350220    60      06/03/05  23:18:37    1      1      S

```

* * * * * (c) Copyright LXI Corp. 1985, 2006 * * * * *

Saved DLO Report

The Display Saved DLO ([DSPSAVDLO](#)) or Work with Saved DLO ([WRKSAVDLO](#)) commands create a report of all saved document library objects. The report is sequenced by document name and save date/time.

```

                                Saved DLO
                                Page      1
                                S1234567  10/26/05  12:16:40

Object  Type  -----Folder-----  Date   Time       Volume  Seq.
FALIST  *FLR  10/17/04  21:03:30  800018  0232
FALIST  *FLR  10/16/04  20:21:00  800112  0024
FALIST  *FLR  10/15/04  23:24:57  800111  0025
FALIST  *FLR  10/15/04  13:11:21  P00001  0001
FALIST  *FLR  10/14/04  23:45:13  800110  0023
FALIST  *FLR  10/14/04  09:10:45  800006  0018
FALIST  *FLR  10/10/04  20:58:44  800002  0229
FALIST  *FLR  10/10/04  07:58:14  800000  0027
FALIST  *FLR  10/03/04  22:01:33  800008  0228
FALIST  *FLR  09/26/04  21:05:05  800035  0219
FALIST  *FLR  09/19/04  21:04:52  800007  0219
FALIST  *FLR  09/12/04  21:01:56  800001  0219
FALIST  *FLR  09/05/04  21:59:17  800012  0219
FALIST  *FLR  08/31/04  09:02:04  800003  0218
FALIST  *FLR  08/23/04  10:03:52  800005  0217
FALIST  *FLR  08/16/04  14:57:05  800016  0214

```

* * * * * (c) Copyright LXI Corp. 1985, 2006 * * * * *

Saved Objects Report

The Display Saved Objects ([DSPSAVOBJ](#)) or Work with Saved Object ([WRKSAVOBJ](#)) commands create a report of all saved objects. The report is sequenced by object name and save date/time. The report can be run for all objects or only user specified objects.

| Saved Objects | | | | | | | | Page | 1 |
|---------------|---------|---------|-----------|----------|----------|--------|-----------|--------|------|
| Object | Library | Type | Attribute | Date | Time | Member | Job Label | Volume | Seq. |
| \$\$\$AR01C | ABCLIB | *PGM | CLP | 09/11/04 | 14:33:08 | | SAVLIB | 700001 | 0019 |
| \$\$\$CDTOR | LXI | *PGM | RPGLE | 09/11/04 | 14:33:08 | | SAVLIB | 700001 | 0022 |
| \$\$\$CDTOR | LXI5.6P | *PGM | RPGLE | 09/11/04 | 14:33:08 | | SAVLIB | 700001 | 0038 |
| \$\$\$CD00P | LXI | *PNLGRP | | 09/11/04 | 14:33:08 | | SAVLIB | 700001 | 0022 |
| \$\$\$CD00P | LXI5.6P | *PNLGRP | | 09/11/04 | 14:33:08 | | SAVLIB | 700001 | 0038 |
| \$\$\$CPAOR | LXI | *PGM | RPGLE | 09/11/04 | 14:33:08 | | SAVLIB | 700001 | 0022 |
| \$\$\$CPAOR | LXI5.6P | *PGM | RPGLE | 09/11/04 | 14:33:08 | | SAVLIB | 700001 | 0038 |
| \$\$\$CUSPF | LXI | *FILE | PF | 09/11/04 | 14:33:08 | CUSREC | SAVLIB | 700001 | 0022 |
| \$\$\$CUSPF | LXI5.6P | *FILE | PF | 09/11/04 | 14:33:08 | CUSREC | SAVLIB | 700001 | 0038 |
| \$\$\$CVOOR | LXI | *PGM | RPGLE | 09/11/04 | 14:33:08 | | SAVLIB | 700001 | 0022 |
| \$\$\$CVOOR | LXI5.6P | *PGM | RPGLE | 09/11/04 | 14:33:08 | | SAVLIB | 700001 | 0038 |
| \$\$\$DMIOP | LXI | *PNLGRP | | 09/11/04 | 14:33:08 | | SAVLIB | 700001 | 0022 |
| \$\$\$DMIOP | LXI5.6P | *PNLGRP | | 09/11/04 | 14:33:08 | | SAVLIB | 700001 | 0038 |
| \$\$\$DMIOR | LXI | *PGM | RPGLE | 09/11/04 | 14:33:08 | | SAVLIB | 700001 | 0022 |
| \$\$\$DMIOR | LXI5.6P | *PGM | RPGLE | 09/11/04 | 14:33:08 | | SAVLIB | 700001 | 0038 |
| \$\$\$ENV | LXI | *FILE | PF | 09/11/04 | 14:33:08 | ENVREC | SAVLIB | 700001 | 0022 |

* * * * * (c) Copyright LXI Corp. 1985, 2006 * * * * *

Saved Links Report

The Display Saved Links ([DSPSAVLNK](#)) or Work with Saved Link ([WRKSAVLNK](#)) commands create a report of all saved object links. The report is sequenced by link name and save date/time. The report can be run for all links or specific links.

```

                                Saved Object Links
                                S1234567 10/03/04 14:23:25
                                Page 1
Object link                    Type   Date       Time       Job Label   Volume   Sequence
/dev                          *DIR     12/31/04   22:41:58   LXI_MTHLY  MK1009   220
/dev/qsh-stdin-null          *STMF    12/31/04   22:41:58   LXI_MTHLY  MK1009   220
/dev/QASP01                  *DIR     12/31/04   22:41:58   LXI_MTHLY  MK1009   220
/dev/QASP02                  *DIR     12/31/04   22:41:58   LXI_MTHLY  MK1009   220
/dev                          *DIR     11/30/04   22:34:11   LXI_MTHLY  MKT036   213
/dev/qsh-stdin-null          *STMF    11/30/04   22:34:11   LXI_MTHLY  MKT036   213
/dev/QASP01                  *DIR     11/30/04   22:34:11   LXI_MTHLY  MKT036   213
/dev/QASP02                  *DIR     11/30/04   22:34:11   LXI_MTHLY  MKT036   213
/dev                          *DIR     11/17/04   15:07:21   SAVE_ALL   MK1099   298
/dev/QASP01                  *DIR     11/17/04   15:07:21   SAVE_ALL   MK1099   298
/dev/QASP02                  *DIR     11/17/04   15:07:21   SAVE_ALL   MK1099   298
/dev                          *DIR     10/31/04   22:22:15   LXI_MTHLY  MKT027   214
/dev/qsh-stdin-null          *STMF    10/31/04   22:22:15   LXI_MTHLY  MKT027   214
/dev/QASP01                  *DIR     10/31/04   22:22:15   LXI_MTHLY  MKT027   214
/dev/QASP02                  *DIR     10/31/04   22:22:15   LXI_MTHLY  MKT027   214
/dev                          *DIR     09/30/04   22:34:16   LXI_MTHLY  350124   211
/dev/qsh-stdin-null          *STMF    09/30/04   22:34:16   LXI_MTHLY  350124   211
/dev/QASP01                  *DIR     09/30/04   22:34:16   LXI_MTHLY  350124   211

```

* * * * * (c) Copyright LXI Corp. 1985, 2006 * * * * *

Scan Log Report

The Scan History Log ([SCNLOG](#)) command creates a report of all entries in the IBM History Log which contain the string entered into the **SCNLOG** command. The report shows the date/time of the message, part of the message text, the message identifier, severity, type, job, user and number.

Scan Log

 Page 1
 S1234567 10/03/04 15:22:45

| Date | Time | Message | Sev. | Type | Job | User | Number |
|----------|----------|--|---------|------|-------|-------|----------------|
| 09/30/04 | 22:20:11 | Log version QHST97266A in QSYS closed and should be | CPF2456 | 00 | *INFO | SCPF | QSYS 000000 |
| 09/30/04 | 22:27:28 | Save file TEST in QTEMP already contains data. (C G) | CPA4067 | 99 | *INFO | DSP01 | QSECOFR 013515 |
| 09/30/04 | 22:27:34 | 5 objects saved from library MMS3.6P; 0 objects not | CPC3723 | 00 | *COMP | DSP01 | QSECOFR 013515 |
| 09/30/04 | 22:32:08 | Save file TEST in QTEMP already contains data. (C G) | CPA4067 | 99 | *INFO | DSP01 | QSECOFR 013515 |
| 09/30/04 | 22:32:11 | 1 objects saved from library TMS5.6P. | CPC3722 | 00 | *COMP | DSP01 | QSECOFR 013515 |
| 09/30/04 | 22:34:35 | Save file TEST in QTEMP already contains data. (C G) | CPA4067 | 99 | *INFO | DSP01 | QSECOFR 013515 |
| 09/30/04 | 22:34:39 | 5 objects saved from library MMS3.6P; 0 objects not | CPC3723 | 00 | *COMP | DSP01 | QSECOFR 013515 |
| 09/30/04 | 22:55:15 | 5 objects restored from MMS3.6P to QMMS. | CPC3703 | 00 | *COMP | DSP01 | QSECOFR 013515 |
| 09/30/04 | 22:58:06 | Save file TEST in QTEMP already contains data. (C G) | CPA4067 | 99 | *INFO | DSP01 | QSECOFR 013515 |
| 09/30/04 | 22:58:10 | 1 objects saved from library TMS5.6P. | CPC3722 | 00 | *COMP | DSP01 | QSECOFR 013515 |
| 09/30/04 | 22:58:35 | 1 objects restored from TMS5.6P to QMMS. | CPC3703 | 00 | *COMP | DSP01 | QSECOFR 013515 |
| 09/30/04 | 23:02:58 | Save file MMS4.2 in TMS5.6P already contains data. (| CPA4067 | 99 | *INFO | DSP01 | QSECOFR 013515 |
| 09/30/04 | 23:03:04 | 12 objects saved from library QMMS; 0 objects not in | CPC3723 | 00 | *COMP | DSP01 | QSECOFR 013515 |
| 09/30/04 | 23:07:10 | Save file MMS4.2 in TMS5.6P already contains data. (| CPA4067 | 99 | *INFO | DSP01 | QSECOFR 013515 |
| 09/30/04 | 23:07:14 | 12 objects saved from library QMMS; 0 objects not in | CPC3723 | 00 | *COMP | DSP01 | QSECOFR 013515 |
| 09/30/04 | 23:09:33 | Save file TMS_5.6P in LXIPRDLIB already contains dat | CPA4067 | 99 | *INQ | DSP01 | QSECOFR 013528 |

Scratch Report

The Display Volume ([DSPVOL](#)) and Work with Volume ([WRKVOL](#)) command create the Volume Scratch report. The report shows the requested volumes in volume identifier sequence. The report is produced by specifying ***SCR** in the **STATUS** parameter. If the default value of ***CURRENT** is specified as the ending date, all volumes that are scratch as of the current date are listed. If the value ***END** is specified as the ending date, all volumes in the MMS/*tms* database are listed in volume identifier sequence. Report information includes the save date/time, status, expiration date, Job Label, and system name.

```

                                         Volumes
                                         Page      1
                                         S1234567 10/03/04 12:45:08

Status . . . : *SCR

Volume  ---Save Date/Time--- Status Expires Job Label  -----Text----- System
006034  09/11/04  08:01:23 *SCR   09/15/04 CVNTST   Conversion Test  S1122334
006116  09/09/04  02:51:41 *SCR   09/14/04 DAILY    Daily Backup    S1122334
006131  09/09/04  02:42:10 *SCR   09/14/04 DAILY    Daily Backup    S1122334
006352  09/09/04  02:47:36 *SCR   09/14/04 DAILY    Daily Backup    S1122334
100223  09/05/04  17:52:17 *SCR   09/06/04 CVNTST   Conversion Test  S1122335
100352  09/08/04  16:23:35 *SCR   09/09/04 CVNTST   Conversion Test  S1122335
100372  09/08/04  16:23:35 *SCR   09/09/04 CVNTST   Conversion Test  S1122335
100452  09/08/04  01:27:22 *SCR   09/13/04 DAILY    Daily Backup    S1122335
100625  09/08/04  01:21:07 *SCR   09/13/04 DAILY    Daily Backup    S1122335
100821  09/08/04  01:15:27 *SCR   09/13/04 DAILY    Daily Backup    S1122335
100911  09/08/04  01:33:02 *SCR   09/13/04 DAILY    Daily Backup    S1122335
800328  10/19/04  12:03:41 *SCR   09/20/04 DAILY    Daily Changes   S1234567

* * * * * (c) Copyright LXI Corp. 1985, 2006 * * * * *

```

Tape Device Report

The Work with Tape Device ([WRKTAPDEV](#)) command creates the Tape Device report. The report shows all devices and the supported densities defined to MMS/*tms*.

```

                                     Tape Devices
                                     Page      1
                                     S1234567 10/03/04 12:24:09

Device   Description                    Function  -----Tape Library-----
TAPMLB01 IBM 3494                             *ALL     *IBM       TAPMLB01
TAPMLB02 IBM 3570                             *ALL     *IBM       TAPMLB02
TAP01    CREATED BY AUTO-CONFIGURATION      *ALL     *NONE      *NONE
TAP08    IBM 3494 Tape library device        *ALL     *NONE      *NONE
TAP09    IBM 3494 Tape library device        *ALL     *NONE      *NONE
TAP10    StorageTek tape library device      *ALL     *SRKSVR    RML01
TAP11    StorageTek tape library device      *ALL     *STKSVR    RML01

      * * * * * (c) Copyright LXI Corp. 1985, 2006 * * * * *
```

Tape Library Report

The Work with Tape Library ([WRKTAPLIB](#)) command creates the Tape Library Volumes report. This report lists all tapes with the specified status in a tape library. The following example shows all scratch volumes in a StorageTek tape library with a library device named RML9710.

```
Tape Library Volumes                                     Page    1
S1234567 10/03/04 14:12:22

Status . . . : *SCR
Device. . . : RML9710

Volume  Date      Time      Status  Expires  Job Label  System  -----Text-----
800124  10/03/04  02:14:56  *SCR   10/08/04  DAILY     S1234567  Daily Changes
800772  10/03/04  02:33:11  *SCR   10/08/04  DAILY     S1234567  Daily Changes
006251  10/02/04  20:21:18  *SCR   10/07/04  DAILY     S1122334  Daily Changes
100826  10/02/04  20:34:09  *SCR   10/07/04  DAILY     S1122334  Daily Changes
100024  10/02/04  17:52:17  *SCR   10/03/04  CVNTST    S1234567  Convert Test

* * * * * (c) Copyright LXI Corp. 1985, 2006 * * * * *
```

Tape Usage Report

The Work with Tape Usage ([WRKTAPUSG](#)) command creates the Tape Usage report. The report shows all densities supported for the specified device. The report also shows the initialization format and the volume range allowed for each density.

```

                                Tape Usage
                                Page      1
                                S1234567 10/03/04 12:34:40

Device:  TAP01

Density  InzFmt  InzNbr  Override  -----Volume Range-----  -----Owner-----
*QIC120  0NNNNN  000000  *YES      *BEGIN  *END  *IGNORE  *ANY
*QIC2GB  0NNNNN  000000  *YES      *BEGIN  *END  *IGNORE  *ANY
*QIC525  0NNNNN  000000  *YES      *BEGIN  *END  *IGNORE  *ANY

      * * * * * (c) Copyright LXI Corp. 1985, 2006 * * * * *

```

MMS/tms Audit Log Report

The IBM Display Log (DSPLOG) command creates the History Log report. This report, when run using **Option 2** from the MMS/*tms* Security menu, selects all MMS/*tms* messages based on the user specified date and time selection criteria.

```
5716SS1 V5R1M0 010525                               History Log                               Page 0001
MSGID  SEV  MSG TYPE
TMS2320 10  INFO      LXI/tms - Communication link S1234567 changed.
                QPADEV0004 LXI      013557      10/01/04 13:08:51
TMS0403 10  INFO      MMS/tms - Volume 800001 deleted.
                S1234567  LXI      013525      10/02/04 10:49:58
TMS0403 10  INFO      MMS/tms - Volume 800003 deleted.
                S1234567  LXI      013525      10/02/04 10:50:15
TMS0403 10  INFO      MMS/tms - Volume 800001 deleted.
                S1234567  LXI      013525      10/02/04 12:11:25
TMS0403 10  INFO      MMS/tms - Volume 800002 deleted.
                S1234567  LXI      013525      10/02/04 12:11:34
TMS0403 10  INFO      MMS/tms - Volume 800003 deleted.
                S1234567  LXI      013525      10/02/04 12:11:39
TMS0403 10  INFO      MMS/tms - Volume 800002 deleted.
                S1234567  LXI      013525      10/02/04 13:01:58
TMS0403 10  INFO      MMS/tms - Volume 800001 deleted.
                S1234567  LXI      013525      10/02/04 13:27:31
TMS0403 10  INFO      MMS/tms - Volume 800003 deleted.
                S1234567  LXI      013525      10/02/04 14:30:42
TMS0403 10  INFO      MMS/tms - Volume 800001 deleted.
                S1234567  LXI      013525      10/02/04 15:04:25
TMS0403 10  INFO      MMS/tms - Volume 800003 deleted.
                S1234567  LXI      013525      10/02/04 15:05:08
TMS0403 10  INFO      MMS/tms - Volume 800002 deleted.
                S1234567  LXI      013525      10/02/04 15:05:46
TMS0403 10  INFO      MMS/tms - Volume 000000 deleted.
                S1234567  LXI      013641      10/03/04 13:00:12
TMS0403 10  INFO      MMS/tms - Volume SPLCAA deleted.
                S1234567  LXI      013641      10/03/04 13:09:36
TMS0403 10  INFO      MMS/tms - Volume P00003 deleted.
                S1234567  LXI      013641      10/03/04 13:11:04
```

Volume Report

The Display Volume ([DSPVOL](#)) and Work with Volume ([WRKVOL](#)) commands create the Volume report. The report shows all volumes in MMS/*tms*. Volumes that are part of a multi-volume set are indented under the first volume in the set. Report information includes the save date/time, status, expiration date, Job Label, location, container/slot name and system name.

```

                                Volumes                                Page    1
                                S1234567 10/03/04 12:45:08

Status . . . : *ALL

Volume  -Save Date/Time- Status Expires  Job Lbl  ----Text----  Location Ctn/Sl't System
800328  10/19/04 12:03:41 *SCR  09/20/04  DAILY    Daily Changes *DFTLOC *NONE S1234567
800108  10/05/04 20:01:42 *ACT  11/23/04  WEEKLY   Weekly Backup *DFTLOC *NONE S1234567
      800273  10/05/04 20:05:20 *ACT  11/23/04  WEEKLY   Weekly Backup *DFTLOC *NONE S1234567
      800188  10/05/04 20:10:18 *ACT  11/23/04  WEEKLY   Weekly Backup *DFTLOC *NONE S1234567
      800083  10/05/04 20:15:03 *ACT  11/23/04  WEEKLY   Weekly Backup *DFTLOC *NONE S1234567
      800104  10/05/04 20:20:17 *ACT  11/23/04  WEEKLY   Weekly Backup *DFTLOC *NONE S1234567
      800136  10/05/04 20:25:48 *ACT  11/23/04  WEEKLY   Weekly Backup *DFTLOC *NONE S1234567
006034  09/11/04 08:01:23 *SCR  09/15/04  CVNTST   Conversion Test *DFTLOC *NONE S1234567
006131  09/09/04 02:42:10 *SCR  09/14/04  DAILY    Daily Backup *DFTLOC *NONE S1234567
006352  09/09/04 02:47:36 *SCR  09/14/04  DAILY    Daily Backup *DFTLOC *NONE S1234567
006116  09/09/04 02:51:41 *SCR  09/14/04  DAILY    Daily Backup *DFTLOC *NONE S1234567
100352  09/08/04 16:23:35 *SCR  09/09/04  CVNTST   Conversion Test *DFTLOC *NONE S1234567
100821  09/08/04 01:15:27 *SCR  09/13/04  DAILY    Daily Backup *DFTLOC *NONE S1234567
100625  09/08/04 01:21:07 *SCR  09/13/04  DAILY    Daily Backup *DFTLOC *NONE S1234567
100452  09/08/04 01:27:22 *SCR  09/13/04  DAILY    Daily Backup *DFTLOC *NONE S1234567
100911  09/08/04 01:33:02 *SCR  09/13/04  DAILY    Daily Backup *DFTLOC *NONE S1234567
100223  09/05/04 17:52:17 *SCR  09/06/04  CVNTST   Conversion Test *DFTLOC *NONE S1234567
100531  09/04/04 20:18:31 *ACT  11/12/04  WEEKLY   Weekly Backup *DFTLOC *NONE S1234567
      100887  09/04/04 20:29:06 *ACT  11/12/04  WEEKLY   Weekly Backup *DFTLOC *NONE S1234567
      100253  09/04/04 20:35:18 *ACT  11/12/04  WEEKLY   Weekly Backup *DFTLOC *NONE S1234567
      100010  09/04/04 20:47:54 *ACT  11/12/04  WEEKLY   Weekly Backup *DFTLOC *NONE S1234567

```

* * * * * (c) Copyright LXI Corp. 1985, 2006 * * * * *

Volume Data Report

The Display Volume Data ([DSPVOLDTA](#)) command creates a report of the contents of a specific tape volume. Report information includes sequence number, object, library, type, attribute, member and save command. The degree of information available on this report is based on the retrieval level specified for the library.

```

                                Saved Objects
                                Page      1
                                S1234567 10/03/04 13:29:01

Volume . . . : 700001
Text. . . . : Daily Backup
System . . . : S1234567
Save date . . : 10/02/04
Save time . . : 20:12:56
Status. . . . : *ACT
Job label . . : DAILY
Expires . . . : 06/10/05
Location . . . : *DFTLOC
Ctn/Slt . . . : *NONE
Returns . . . : 00/00/00
Base volume . : 700001

Seq. Object Library Type Attribute Member Command -----Text-----
0002 $CONSRC QSYS *LIB PROD SAVLIB CON - (c) Copyright LXI
0002 CONMSGF $CONSRC *MSGF SAVLIB Console Message file
0002 QCLSRC $CONSRC *FILE PF SAVLIB Console CLP Source
0002 QCMSRC $CONSRC *FILE PF SAVLIB Console CMD Source
0002 QDDSRC $CONSRC *FILE PF SAVLIB Console DDS Source
0002 QMENSRC $CONSRC *FILE PF SAVLIB Console MNU Source
0002 QMISRC $CONSRC *FILE PF SAVLIB Console MI Source
0002 QPNLSRC $CONSRC *FILE PF SAVLIB Console PNL Source
0002 QRPGRS $CONSRC *FILE PF SAVLIB Console RPG Source
0002 QSRCSRC $CONSRC *FILE PF SAVLIB Console CMD Source
0002 QXTSRC $CONSRC *FILE PF SAVLIB Console TXT Source
0003 $ESSSRC QSYS *LIB PROD SAVLIB ESS - (c) Copyright LXI
0003 C$SS01 $ESSSRC *MSGF SAVLIB
0003 C$SS01 $ESSSRC *FILE DSPF SAVLIB

* * * * * (c) Copyright LXI Corp. 1985, 2006 * * * * *

```

Volume Information Report

The Display Volume Information ([DSPVOLUME](#)) command creates a report listing the characteristics of the specified volume. The report contains volume, media, save and location information.

```

                                Volume Information
                                Page      1
                                S1234567 10/03/04 13:52:52

Volume . . . . . : 700001
Volume text . . . : Daily Backup
Volume information:
Status . . . . . : *SCR
Sequence . . . . . : 1
File sequence . . . . . : 68
Retention cycle . . . . . : 1
Initial:
Job . . . . . : DSP01
User . . . . . : QSECOFR
Number . . . . . : 012340
Date/Time . . . . . : 09/11/04 14:32:20
Security . . . . . : *NONE
Media information:
Owner . . . . . : *BLANK
Class . . . . . : *QIC
Code . . . . . : *EBCDIC
Density . . . . . : *QIC2GB
Block count . . . . . : 0
Block length . . . . . : 32760
Record length . . . . . : 0
Save information:
System . . . . . : S1234567
Job Label . . . . . : DAILY
Device:
Name . . . . . : TAP04
Type . . . . . : 3490
Text . . . . . : StorageTek 3490 Tape Library Device
Save:
Job . . . . . : DSP010100
User . . . . . : QSYSOPR
Number . . . . . : 012346
Date/Time . . . . . : 09/11/04 15:01:43
Expiration date . . . . . : 09/12/04
Location information:
Current location . . . . . : *DFTLOC
Container . . . . . : *NONE
Location:
Job . . . . . : DSP010100
User . . . . . : QSYSOPR
Number . . . . . : 012346
Date/Time . . . . . : 09/11/04 15:01:43
Return date . . . . . : 00/00/00

```

* * * * * (c) Copyright LXI Corp. 1985, 2006 * * * * *

Volume Label

The Print Volume Label ([PRTVOLLBL](#)) command creates the Volume label. The tape label printer files reside in library **LXITMS400**.

```
Tape: 700001 Cycle: 1 Vol #: 1  
Created: 9/11/04 Expires: 9/12/04  
Text: Test Job Label
```

Volume Status Report

The Print Volume Status ([PRTVOLSTS](#)) command creates the Volume status report. This report lists all tape saves/copies performed within the last 24-hour period. The 24-hour period is based on when the command is run.

```

                                Volumes
                                Page      1
                                S1234567 10/03/04 14:12:22

Status . . . : *ALL

Volume  ---Save Date/Time---  Status  Expires  Job Label  -----Text-----  System
800124  10/03/04   02:14:56  *ACT    10/08/04  DAILY     Daily Changes  S1234567
800772  10/03/04   02:33:11  *ACT    10/08/04  DAILY     Daily Changes  S1122334
006251  10/02/04   20:21:18  *ACT    10/07/04  DAILY     Daily Changes  S1122335
100826  10/02/04   20:34:09  *ACT    10/07/04  DAILY     Daily Changes  S1122336
100024  10/02/04   17:52:17  *SCR    10/03/04  CVNTST    Conversion Test S1122335

          * * * * * (c) Copyright LXI Corp. 1985, 2006 * * * * *
    
```

Chapter 17

Tape Management Commands

MMS/*tms* is a command-driven product. Even in the MMS/*tms* menus, commands are executed to perform the requested function. If desired, these commands can be used directly instead of the menus to provide faster access to MMS/*tms* functions. Not all commands can be used in the same environment. Some commands can only be used interactively (**I**), some only in batch (**B**) and others are available for all environments (**B/I**). Commands are restricted to the environment for which they were created. Before using a MMS/*tms* command, ensure that it is allowed in the environment from which you wish to execute it.

The following pages show all of the MMS Tape Management commands with their parameters and a brief description of each parameter's purpose.

The commands are listed in alphabetical sequence.

ADDCMNLNK - Add Communication Link

| Add Communication Link (ADDCMNLNK) | | Environment: B/I |
|------------------------------------|--------------------------|---------------------|
| Remote location | | Name |
| System name | <u>*RMTLOCNAME</u> | Name, *RMTLOCNAME |
| Link type | <u>*CPIC</u> | *CPIC, *TCP |
| Device description | <u>*LOC</u> | Name, *LOC |
| Local location name | <u>*LOC</u> | Name, *LOC, *NETATR |
| Mode | <u>*NETATR</u> | Name, *NETATR |
| Remote network identifier | <u>*LOC</u> | Name, *LOC, *NETATR |
| Transaction program | <u>'LXITMS/TM\$CPIR'</u> | |
| Platform | <u>*OS400</u> | *OS400, *UNIX |
| Internet address | <u>*TCPHTE</u> | Char, *TCPHTE |
| Remote port number | <u>*PRDOPT</u> | 1-65535, *PRDOPT |
| Local internet address | <u>*PRDOPT</u> | Char, *ANY, *PRDOPT |

Purpose

The Add Communication Link (ADDCMNLNK) command creates a CPIC or TCP/IP communication link from the local (source) system to a remote (target) system. Communication links allow MMS/*tms* from different iSeries to share volume information with supported AIX and UNIX tape management systems and use a common tape pool. The communication path between the source and target systems must already exist before using this command. MMS/*tms* verifies that the communication link works before adding it.

Parameters

- RMTLOCNAME:** Specifies the remote (target) system location name used with this communication link.
- Remote-location* Enter a valid remote location.
- SYSTEM:** Specifies the actual system name of the remote (target) system.
- *RMTLOCNAME The system name is the same as the remote location name.
- System-name* Enter a valid system name.
- LNKTYPE:** Specifies the type of communication link to the remote (target) system.
- *CPIC CPIC is used to communicate with the remote system.
- *TCP TCP/IP is used to communicate with the remote system.

DEV: Specifies the name of the source system communications device that is used with this communication link.

***LOC** The communications device associated with the remote location is used. If several devices can be associated with the remote location, the system determines which device is used.

Device-name Enter a valid device name.

LCLLOCNAME: Specifies the local location name.

***LOC** The local location name specified for the remote location is used.

*NETATR The LCLLOCNAME value specified in the system network attributes is used.

Local-location Enter the local location name used with the remote location name. The local location name is only specified to indicate a specific local location for the remote location.

MODE: Specifies the mode name that is used with the remote location name to communicate with the remote (target) system.

***NETATR** The mode in the network attributes is used.

Mode-name Enter the name of the mode.

More information on modes can be found in the [APPC Programming](#) book.

RMTNETID: Specifies the identifier (ID) of the remote network in which the remote location resides. The identifier is used to communicate with the remote (target) system.

***LOC** The remote network identifier specified for the remote location is used.

*NETATR The remote network identifier specified in the network attributes is used.

Network-ID Enter the remote network identifier that is used with the remote location name. The remote network identifier is specified only to indicate a specific remote network identifier for the remote location.

More information on remote network IDs can be found in the [APPC Programming](#) book.

- TNSPGM:** Specifies the name (up to 64 characters) of the transaction program, on the remote system, to be started.
- TM\$CPIIR** The transaction program to use when the remote (target) system and local (source) systems are using MMS/*tms* 4.5.1 and above.
- Program-name* Enter the name of the transaction program to use on the remote (target) system.
- PLATFORM:** Specifies the type of remote (target) system.
- *OS400** The remote system is an iSeries.
- *UNIX** The remote system is a UNIX system.
- INTNETADR:** Specifies the Internet address of the remote (target) system. The format of the Internet address is nnn.nnn.nnn.nnn where nnn is a decimal number ranging from 0 through 255.
- *TCPHTE** The Internet address defined in the **TCP/IP** Host Table Entries for the specified remote location name is used.
- Internet-address* Enter the Internet address of the remote (target) system.
- RMTPORT:** Specifies the port number being used by the remote (target) system. **Note:** *Ports 1 through 1023 are used by system-supplied TCP/IP applications. If the user specifies one of these ports, it can affect the operation of those applications. See the assigned numbers RFC for the definition of port numbers currently used by TCP/IP applications.*
- *PRDOPT** The value defined in the MMS/*tms* Product Options is used.
- 1-65535* Enter a remote port number.
- LCLINTNETA:** Specifies the local Internet address of the communication link that the outbound data is to use. If the Internet address is entered from a command line, the address must be enclosed in apostrophes. The format of the Internet address is nnn.nnn.nnn.nnn where nnn is a decimal number ranging from 0 through 255.
- *PRDOPT** The value defined in the MMS/*tms* Product Options is used.
- *ANY** Any local Internet address is used.
- Internet-address* Enter the Internet address of the remote (target) system.

Examples

```
ADDCMNLNK RMTLOCNAME(SYSTEMB) LNKTYPE(*CPIC) TNSPGM(LXITMS/TM$CPI1R)
```

This adds a CPIC communication link to a remote (target) system named SYSTEMB. All values, except remote location name and the transaction program, use defaults.

ADDJOBLBL - Add Job Label

| Add Job Label (ADDJOBLBL) | | Environment: B/I |
|--------------------------------|----------------|---------------------------|
| Job label | _____ | |
| Data retention: | | |
| Generation | 0 | 0-9999 |
| Days | <u>*PERM</u> | 9000, *PERM |
| Type of information to retain: | | |
| Document library object | <u>*BASIC</u> | *BASIC, *ALL |
| Lotus Notes/Domino | <u>*BASIC</u> | *BASIC, *ALL |
| Integrated file system | <u>*BASIC</u> | *BASIC, *ALL |
| Libraries and objects | <u>*LIB</u> | *LIB, *OBJ, *MBR, *USRDFN |
| Save files | <u>*BASIC</u> | *BASIC, *ALL, *USRDFN |
| Referenced tape pool | <u>*JOBLBL</u> | Name, *JOBLBL |
| System | _____ | Name, *CURRENT |
| Print volume label | <u>*NO</u> | *NO, *YES |
| Text 'description' | _____ | |
| Tape Pool: | | |
| Beginning | <u>*DEV</u> | Character value, *DEV |
| Ending | <u>*DEV</u> | Character value, *DEV |
| Last used | <u>*AVAIL</u> | Character value, *AVAIL |
| Usage | <u>*DEV</u> | *DEV, *ANY, *NEXT, *LAST |
| Tape range error | <u>*DEV</u> | *DEV, *IGNORE, *REJECT |

Purpose

The Add Job Label (ADDJOBLBL) command creates a Job Label for an output (write) tape function. The Job Label establishes data retention, text, data retrieval levels, tape label printing requirements and tape pool attributes. Job Labels, if used, ensure data retention and usage consistency whenever the tape function occurs.

Job Labels can cross system boundaries. A Job Label created on one system can reference tape pool information on another system in the MMS/*tms* network.

Parameters

JOBLBL: Specifies the name (up to 20-characters) of the Job Label.
Job-label Enter a valid Job Label.

VOLRET: Specifies the type of retention that is used for all volumes created by this Job Label. If generations *and* days are specified, the generation requirements must be met *before* the day requirements are used to determine the status of a volume.

Generation: Specifies the number of tapes that are in active status. The following precautions and recommendations should be observed when using retention by generations.

- Generations are automatically recalculated when a:
 - Job Label is changed or deleted
 - Volume is added, changed to another Job Label, deleted, initialized, scratched or reused.
- Performing multiple saves with different generations onto the same tape is not allowed. MMS/*tms* unloads the current tape and mounts a scratch tape when trying to append generations to the same tape.
- If appending data, use retention by days.
- If retention by generation is used, a minimum of 1 day should also be specified. This helps protect the tape in a multiple system environment if the MMS/*tms* network is down or the systems are in restricted state.

0 No generations are required.

0-9999 Enter the number of generations required for this Job Label.

Days: Specifies the number of days that the volumes are in active (not available for use) status.

***PERM** The tapes are permanently active.

0 - 9000 Enter a value from 0 to 9000 that defines the number of days the tapes are active.

RTVLVL: Specifies the amount of information that is retrieved and written to the MMS/*tms* database for the various types of OS/400 file systems and related objects. The retrieval level should be based on your requirements for detailed recovery information. The retrieval level for libraries can be a global value or can be user-defined on a library by library basis.

| | |
|-------------------------|--|
| <u>DLO detail:</u> | Specifies the retrieval level for folders/documents. |
| *BASIC | Saved folders and documents are not written to the database. |
| *ALL | Saved folders and documents are written to the database. |
| <u>Domino detail:</u> | Specifies the retrieval level for Lotus Notes/Domino objects. |
| *BASIC | Saved Lotus Notes/Domino objects are not written to the database. |
| *ALL | Saved Lotus Notes/Domino objects are written to the database. |
| <u>IFS detail:</u> | Specifies the retrieval level for Integrated File System objects. |
| *BASIC | Saved Integrated File System objects are not written to the database. |
| *ALL | Saved Integrated File System objects are written to the database. |
| <u>Object detail:</u> | Specifies the retrieval level for objects. |
| *LIB | The library name is written to the database. No other information about the saved library or saved objects is available. |
| *OBJ | The library and object information is written to the database. |
| *MBR | The library, object, and member information is written to the database. |
| *USRDFN | The retrieval level is user-defined. Refer to the <i>Change Retrieval Level (CHGRTVLVL)</i> command for additional information. |
| <u>Save-file Level:</u> | Specifies if save file contents are retrieved. |
| *BASIC | No save-file contents are written to the database when an embedded save-file is found. |
| *ALL | Save-files contents are written to the database. The contents of save-files within the first level save-files are not retrieved. |
| *USRDFN | The retrieval level is user-defined. Refer to the <i>Change Retrieval Level (CHGRTVLVL)</i> command for additional information. |

REFLBL: Specifies that this Job Label references another Job Labels tape pool information. Referencing another Job Label tape pool provides the ability to put several different Job Labels on the same tape. Job Labels cannot reference a Job Label that is referencing another Job Label. Referenced Job Labels cannot be deleted until all references have been removed.

Job Label: Specifies the name of the Job Label being referenced.

***JOBLBL** The current Job Label is referenced.

Job-label Enter a valid Job Label.

System: Specifies the name of the system that contains the Job Label being referenced. The system must be defined in the MMS/*tms* network.

***CURRENT** The referenced Job Label resides on the current system.

System-name Enter a system name.

VOLLBL: Specifies if tape labels are printed for volumes created by this Job Label.

***NO** No tape labels are printed.

***YES** Tape labels are printed.

TEXT: Specifies the text that briefly describes the object.

'description' Enter no more than 50 characters of text, enclosed in apostrophes.

| | |
|----------------------------|---|
| POOL: | Specifies the range of volumes allowed and the action to take if a volume that is not within the range is mounted. |
| <u>Beginning:</u> | Specifies the first volume in the pool range. |
| <u>*DEV</u> | The beginning volume is defined in the tape usage of the tape device being used. |
| <i>Volume-id</i> | Enter the beginning volume identifier. |
| <u>Ending:</u> | Specifies the last volume in the pool range. |
| <u>*DEV</u> | The last volume in the range is defined by the tape device. |
| <i>Volume-id</i> | Enter the ending volume identifier. |
| <u>Last Used:</u> | Specifies the last volume used. |
| <u>*AVAIL</u> | MMS/ <i>tms</i> uses the first available volume from within the range. |
| <i>Volume-id</i> | Enter the last used volume identifier. |
| <u>Usage:</u> | Specifies how volumes from this pool are selected. |
| <u>*DEV</u> | The volume usage is defined by the tape device. |
| *ANY | Any volume within the range is accepted. This value can be used by some tape libraries. If used, it forces the tape library server to select the volume. |
| *NEXT | The next available volume <i>after</i> the one specified for the Last used parameter is selected. If one doesn't exist, the first available volume is selected. |
| *LAST | The volume specified for the Last used parameter is selected. If it doesn't exist, the first available scratch volume is selected. A scratch volume is selected if, during processing, a continuation volume is required. |
| <u>Range Error:</u> | Specifies the action to take if the volume is not within range. |
| <u>*DEV</u> | The tape range error is defined in the tape Device Definition. |
| *IGNORE | The tape range error is ignored. |
| *REJECT | The tape is unloaded. An available scratch tape is mounted if a tape is rejected in a tape library. |

Examples

```
ADDJOBLBL JOBLBL(DAILY) TEXT('Daily Backups') VOLRET(5 5)
```

This adds a Job Label named DAILY with a retention of 5 generations and 5 days. Since generations and days are specified, the tapes remain active until the sixth run of this job. At that time, the oldest job is removed from generation control and the expiration date will be used to determine the status (active/scratch) of the tape. No tape labels are printed, objects are tracked at library level and all tape pool requirements default to the device.

```
ADDJOBLBL JOBLBL(WEEKLY) TEXT('Weekly Backups') VOLRET(0 30) +  
  INFTYPE(*SAME *SAME *SAME *OBJ *ALL) VOLLBL(*YES) +  
  POOL(800000 800100 800034 *NEXT *REJECT)
```

This adds a Job Label named WEEKLY with a retention of 30 days. The objects saved are tracked at object level and if a save-file is saved, its' contents are tracked. Tape labels are printed for each tape used. This job requires that the tapes be in the range of 800000 to 800100. The last volume used was 800034. The job mounts the next available scratch tape and rejects any tape not within range.

ADDRTVLVL - Add Retrieval Level

| | | |
|---------------------------------|-------------|------------------|
| Add Retrieval Level (ADDRTVLVL) | | Environment: B/I |
| Library | _____ | Name |
| Information type: | | |
| Retrieval level | <u>*LIB</u> | *LIB, *OBJ, *MBR |
| Save file contents | <u>*NO</u> | *NO, *YES |

Purpose

The Add Retrieval Level (ADDRTVLVL) command adds the retrieval level of a library and/or save-file. Changing the retrieval level to object or member provides detail information on the saved objects for recovery purposes. This level of information requires additional resources, processing time and disk space. Changing the retrieval level to library level reduces detailed saved object information but increases processing speed and minimizes disk space. Changing the retrieval level is not allowed for some IBM libraries.

Parameters

- LIBRARY:** Specifies the name of the library to change.
Library-name Enter a valid library name.
- RTVLVL:** Specifies the amount of information that is retrieved and written to the database.
- Retrieval Level:** Specifies the retrieval level for libraries.
- *LIB** The library name is written to the database. No other information about the saved library is available. No save-file retrieval is allowed. Space requirements = Number of libraries * 269.
 - *OBJ** The library and its objects are written to the database. Space requirements = ((Number of Objects * 269) + 269).
 - *MBR** The library and its objects and members are written to the database. Space requirements = ((Number of Members in all Objects * 269) + (Number of Objects * 269) + 269).
- Save-file Level:** Specifies whether the contents of save files written to tape are cataloged.
- *NO** No save-file contents are written to the database when a save-file is written to tape.
 - *YES** Save-files contents are written to the database. The contents of save-files within the first level save-files are not retrieved.

Examples

```
ADDRTVLVL LIBRARY(ACCTLIB) RTVLVL(*OBJ *YES)
```

This adds object level retrieval for library ACCTLIB. This means that the library description, and that of every object saved from the library, will be written to the database. If one of the objects saved is a save-file, it is tracked at object level (all objects within the save file are written to the database).

ADDTAPDEV - Add Tape Device

| Add Tape Device (ADDTAPDEV) | | Environment: B/I |
|-----------------------------|------------------|------------------------------|
| Device name | _____ | Name |
| Share device | <u>*NO</u> | *NO, *YES |
| Function supported ... | <u>*ALL</u> | *READ, *WRITE, *ALL |
| Usage | <u>*ANY</u> | *ANY, *NEXT |
| Tape library information: | | |
| Library type | <u>*NONE</u> | *NONE, *IBM, *MTX, *STKDA... |
| Library device | <u>*NONE</u> | Name, *NONE |
| Destination | <u>*DEV</u> | Name, *CAS, *CNV, *DEV... |
| Category: | | |
| Category name | <u>*SHARE400</u> | *NOSHARE, *SHARE400... |
| Category system | <u>*CURRENT</u> | *CURRENT,... |
| Text 'description' | <u>*DEV</u> | |

Purpose

The Add Tape Device (ADDTAPDEV) command defines a tape device and its attributes to MMS/*tms*. Tape device attributes include the tape densities, tape functions supported, device category, and tape library information. Only devices, which have been defined, are supported by MMS/*tms*. The existence of the tape device is verified before being added.

Parameters

- DEV:** Specifies the name of the Device Definition to add.
- Device-name* Enter a valid device name.
- SHARE:** Specifies if the device is shared. A shared device is one that is varied off if its not being used. When a job needs a tape device, it is varied on, used, and then varied off again. A non-shared device remains varied on when not in use. Device sharing allows a device to be used as needed. When using an IBM tape library, ***NO** must be specified.
- *NO** The device is not shared. The device remains varied on when not in use.
- *YES** The device is shared with other systems/jobs. The device is varied off when not in use.
- FUNCTION:** Specifies the tape functions supported by this Device Definition.
- *ALL** All tapes are tracked/managed.
- *READ** Input tapes (tapes read from) are tracked/managed.
- *WRITE** Output tapes (tapes written to) are tracked/managed.

USAGE: Specifies how volumes from this pool are selected.

***ANY** Any volume within the range is selected. This value can be used by some tape libraries. If used, it forces the tape library server to select the volume.

*NEXT The next available volume *after* the one specified on the Last used parameter of the Job Label is selected. If one doesn't exist, the first available volume is selected.

TAPLIB: Specifies the information required for an automated tape library.

Library type: Specifies the type of tape library.

***NONE** The device is not a tape library.

*IBM IBM tape library.

*MTX Memorex/Telex tape library.

*STKDA StorageTek direct attach tape library.

*STKLS StorageTek library station tape library.

*STKSVR StorageTek server attach tape library.

Library device: Specifies the name of the library device (tape library robot).

***NONE** No library device is associated with this tape library.

Library-device Enter the name of the library device associated with the tape library.

Destination: Specifies the destination to receive the tapes being ejected.

***DEV** For IBM Tape Libraries. The tape is placed in the convenience I/O station or storage slot within the library.

*CAS For MTX Tape Libraries. The tape is placed into the MTX cartridge access station.

*CNV For IBM Tape Libraries. The tape is placed into the IBM convenience I/O station.

*HIGHCAP For IBM Tape Libraries. The tape is placed into the IBM high capacity output station.

Destination Enter the name of the output destination.

CGY: Specifies the IBM tape category attributes.

Category name: Specifies the type of tape library.

***SHARE400** The cartridges can be shared with other iSeries systems that are attached to the same device.

***NOSHARE** The cartridges can be shared with other iSeries systems that are attached to the same device.

Category-name Enter the IBM tape category to which the tape is added or changed.

Category system: Specifies the system to which the category belongs. The system name is obtained from the pending system name field of a Display Network Attributes (DSPNETA) command. If there is no pending system name, the current system name attribute is used.

**** Attention ****

If the system name is changed, the category information associated with all tape cartridges in library devices is not valid.

***CURRENT** The category belongs to the system currently running the command.

System-name Enter a valid system name.

TEXT: Specifies the text that briefly describes the object.

***DEV** The text associated with the device description is used.

'description' Enter no more than 50 characters of text, enclosed in apostrophes.

Examples

ADDTAPDEV DEV(TAP01)

This adds a device named TAP01. The device tracks output tapes (tapes that are written to) and the device is not shared or part of a tape library.

ADDTAPDEV DEV(TAP08) SHARE(*YES) TAPLIB(*STKLS) LIBDEV(RML01)

This adds a device named TAP08. This device resides in a StorageTek Library Station attached tape library whose library device name is RML01. The device is shared, which means that it is varied on when required for use and varied off when complete.

ADDDVOL - Add Volume

| Add Volume (ADDDVOL) | | Environment: B/I |
|------------------------------|-----------------|----------------------|
| Volume identifier | _____ | Character value |
| + for more values | | |
| Save date | <u>*CURRENT</u> | Date, *CURRENT |
| Save time | <u>*CURRENT</u> | Time, *CURRENT |
| Expiration date | <u>*PERM</u> | Date, *PERM, *JOBLBL |
| Owner | <u>*BLANK</u> | Char, *BLANK |
| Job label | <u>*NONE</u> | *NONE, *DFT |
| Text 'description' | <u>*BLANK</u> | |
| Device | <u>*NONE</u> | Name, *NONE |
| Volume contents | <u>*NO</u> | *NO, *YES |

Purpose

The Add Volume (ADDDVOL) command manually adds a volume. This command provides the ability to add volumes from other platforms to the MMS/*tms* database. The command also allows you to add volume contents, if required, and associate it with a Job Label. If a MMS/*tms* network exists, the volumes are added to all remote databases.

Parameters

- VOL:** Specifies the volume identifier to add. Existing volumes cannot be added unless they are in scratch status. If they are, the information from this command updates them. If the volume is not in scratch status, an escape message is sent to the requestor.
- Volume-id* Enter a valid volume identifier.
- SAVDATE:** Specifies the save date of the volume. The save date cannot be greater than the current date.
- *CURRENT The current date is used as the save date.
- Save-date* Enter a valid save date.
- SAVTIME:** Specifies the save time of the volume.
- *CURRENT The current time is used as the save time.
- Save-time* Enter a valid save time.
- EXPDATE:** Specifies when the volume expires. If the special value ***JOBLBL** is used, the expiration date and volume status is based on the Job Label attributes.
- *PERM The volume has a permanent retention. The volume does not expire.
- *JOBLBL** The expiration date is based on the retention specified in the Job Label. If the Job Label uses generations, MMS/*tms* recalculates the generations for the Job Label.
- Expiration-date* Enter a valid expiration date. The expiration date must be greater than the save date.

| | |
|----------------------|--|
| OWNID: | Specifies the owner associated with this volume. |
| <u>*BLANK</u> | No owner is associated with the volume. |
| <i>Owner-name</i> | Enter a volume owner. |
| JOBLBL: | Specifies the Job Label to associate with the volume(s) being added. |
| <u>*NONE</u> | No Job Label is associated with the volume(s). |
| *DFT | The default Job Label is used. |
| <i>Job-label</i> | Enter a valid Job Label. |
| TEXT: | Specifies the text that briefly describes the object. |
| <u>*BLANK</u> | No text is associated with this volume. |
| *JOBLBL | The text from the Job Label is used. |
| <i>'description'</i> | Enter no more than 50 characters of text, enclosed in apostrophes. |
| DEV: | Specifies the tape device used to save to this volume. |
| <u>*NONE</u> | No save device is associated with this volume. |
| <i>Device-name</i> | Enter a valid device name. |
| CONTENTS: | Specifies if volume contents are added to this volume description. If volume contents are being added, MMS/ <i>tms</i> prompts you for the information. When adding volume contents, MMS/ <i>tms</i> ensures volume sequence integrity. Sequence numbers must be used sequentially and only one library can exist per sequence number. |
| <u>*NO</u> | Volume contents are not added. |
| *YES | Volume contents are added. |

Examples

```
ADDVOL VOL(001000) SAVDAT(080104) SAVTIME(083045) EXPDATE(090104) +
      TEXT('Daily Backup')
```

This adds a volume named 001000. The volume was created on 08/01/04 at 08:30:45 and it expires on 09/01/04.

```
ADDVOL VOL(001000) SAVDAT(080104) SAVTIME(083045) EXPDATE(*JOBLBL) +
      JOBLBL(DAILY) TEXT(*JOBLBL)
```

This adds a volume named 001000. The volume was created on 08/01/04 at 08:30:45 and the expiration date and text on based on the Job Label DAILY. Job Label DAILY must exist.

ALCTAPDEV - Allocate Tape Device

Allocate Tape Device (ALCTAPDEV)

Environment: B/I

| | | |
|-----------------------------|-----------------|-------------------------------|
| Device name | _____ | Name, *SELECT |
| Force to named device | <u>*NO</u> | *NO, *YES |
| Tape Density | <u>*DEVTYPE</u> | *DEVTYPE, *QIC120, *QIC525... |
| Device class | <u>*CART</u> | *CART, *QIC, *REEL, *8MM |

Purpose

The Allocate Tape Device (ALCTAPDEV) command allocates a tape device. Tape device allocation is required when using the MMS/*tms* device sharing capability. If the device being allocated is not available, this command searches for a similar device, as specified in the command parameters, and allocates it. If no devices are available, an inquiry message is sent to the requestor.

Parameters

DEV: Specifies the name of the device to allocate.

***SELECT** Device allocation is based on density and device class.

Device-name Enter a valid device name.

FORCE: Forces a job to the specified device if the device category is ***SHARE**. If the device is not available, an escape message is sent to the requestor.

***NO** The allocation is not forced to the specified device.

***YES** The device specified in the **DEV** parameter must be allocated. If the device is not available, an escape message is sent to the requestor.

DENSITY: Specifies the supported density of the device to be allocated.

***DEVTYPE** Any density supported by the allocated device is used.

Density Enter the density required for the allocation.

DEVCLS: Specifies the device class of the device to be allocated.

***CART** 1/2" cartridge.

***QIC** 1/4" cartridge.

***REEL** Reel.

***8MM** 8mm cartridge.

Examples

ALCTAPDEV DEV(TAP01)

This allocates a device named TAP01. If the device category is *SHARE and TAP01 is in use, MMS/*tms* searches for an available device and return the selected device in the completion message. If no device is available, an escape message is sent to the requestor. If TAP01 category is *NOSHARE, and it is not available for use, an escape message is sent to the requestor.

ALCTAPDEV DEV(*SELECT) DENSITY(*FMT3590)

This allocates a 3590 device. MMS/*tms* searches its list of shared devices for a device that supports 3590. The selected device, if any, is returned in the completion message. If no device is available, an escape message is sent to the requestor.

ALCTAPDEV DEV(*SELECT) DENSITY(*DEVTYPE) DEVCLS(*REEL)

This allocates a *REEL device. MMS/*tms* searches its list of shared devices for a device that is defined as a *REEL device. The selected device, if any, is returned in the completion message. If no device is available, an escape message is sent to the requestor.

CHGCMNLNK - Change Communication Link

Change Communication Link (CHGCMNLNK) Environment: B/I

| | | |
|---------------------------------|--------------|----------------------------|
| Remote location | | Name |
| System name | <u>*SAME</u> | Name, *SAME, *RMTLOCNAME |
| Link type | <u>*SAME</u> | *SAME, *CPIC, *TCP |
| Device name | <u>*SAME</u> | Name, *SAME, *LOC |
| Local location name | <u>*SAME</u> | Name, *SAME, *LOC, *NETATR |
| Mode | <u>*SAME</u> | Name, *SAME, *NETATR |
| Remote network identifier | <u>*SAME</u> | Name, *SAME, *LOC, *NETATR |
| Transaction program | <u>*SAME</u> | Char, *SAME |
| Internet address | <u>*SAME</u> | Char, *SAME, *TCPHTE |
| Remote port number | <u>*SAME</u> | 1-65535, *SAME, *PRDOPT |
| Local Internet address | <u>*SAME</u> | Char, *SAME, *PRDOPT, *ANY |

Purpose

The Change Communication Link (CHGCMNLNK) command changes an existing CPIC or TCP/IP communication link. Communication links allow MMS/*tms* from different iSeries to share volume information with other iSeries, or UNIX tape management systems and use a common tape pool. The communication path between the source and target systems must already exist and be operational before using this command. MMS/*tms* verifies that the communication link works before changing it.

Parameters

RMTLOCNAME: Specifies the remote (target) system location name used with this communication link.

Remote-location Enter a valid remote location.

SYSTEM: Specifies the actual system name of the remote (target) system.

***SAME** Retain the current value.

***RMTLOCNAME** The system name is the same as the remote location name.

System-name Enter a valid system name.

LNKTYPE: Specifies the type of communication link to the remote (target) system.

***SAME** Retain the current value.

***CPIC** CPIC is used to communicate with the remote system.

***TCP** TCP/IP is used to communicate with the remote system.

DEV: Specifies the name of the source system communications device that is used with this communication link.

- *SAME** Retain the current value.
- *LOC The communications device associated with the remote location is used. If several devices can be associated with the remote location, the system determines which device is used.
- Device-name* Enter a valid device name.

LCLLOCNAME: Specifies the local location name.

- *SAME** Retain the current value.
- *LOC The local location name specified for the remote location is used.
- *NETATR The LCLLOCNAME value specified in the system network attributes is used.
- Local-location* Enter the local location name used with the remote location name. The local location name is only specified to indicate a specific local location for the remote location.

MODE: Specifies the mode name that is used with the remote location name to communicate with the remote (target) system.

- *SAME** Retain the current value.
 - *NETATR The mode in the network attributes is used.
 - Mode-name* Enter the name of the mode.
- More information on modes can be found in the [APPC Programming](#) book.

RMTNETID: Specifies the identifier (ID) of the remote network in which the remote location resides. The identifier is used to communicate with the remote (target) system.

- *SAME** Retain the current value.
 - *LOC The remote network identifier specified for the remote location is used.
 - *NETATR The remote network identifier specified in the network attributes is used.
 - Network-ID* Enter the remote network identifier that is used with the remote location name. The remote network identifier is specified only to indicate a specific remote network identifier for the remote location.
- More information on remote network Ids can be found in the [APPC Programming](#) book.

| | |
|-------------------------|---|
| TNSPGM: | Specifies the name (up to 64 characters) of the transaction program, on the remote system, to be started. |
| <u>*SAME</u> | Retain the current value. |
| TM\$CPI1R | The transaction program to use when the remote (target) system and local (source) systems are using MMS/ <i>tms</i> 4.5.1 and above. |
| <i>Program-name</i> | Enter the name of the transaction program to use on the remote (target) system. |
| INTNETADR: | Specifies the Internet address of the remote (target) system. The format of the Internet address is nnn.nnn.nnn.nnn where nnn is a decimal number ranging from 0 through 255. |
| <u>*SAME</u> | Retain the current value. |
| <i>Internet-address</i> | Enter the Internet address of the remote (target) system. |
| RMTPORT: | Specifies the port number being used by the remote (target) system. Note: <i>Ports 1 through 1023 are used by system-supplied TCP/IP applications. If the user specifies one of these ports, it can affect the operation of those applications. See the assigned numbers RFC for the definition of port numbers currently used by TCP/IP applications.</i> |
| <u>*SAME</u> | Retain the current value. |
| *PRDOPT | The value defined in the MMS/ <i>tms</i> Product Options is used. |
| <i>1-65535</i> | Enter a remote port number. |
| LCLINTNETA: | Specifies the local Internet address of the communication link that the outbound data is to use. If the Internet address is entered from a command line, the address must be enclosed in apostrophes. The format of the Internet address is nnn.nnn.nnn.nnn where nnn is a decimal number ranging from 0 through 255. |
| <u>*SAME</u> | Retain the current value. |
| *PRDOPT | The value defined in the MMS/ <i>tms</i> Product Options is used. |
| <i>Host-name</i> | Enter up to 255 characters for the host name. |

Examples

```
CHGCMNLNK RMTLOCNAME(SYSTEMB) LNKTTYPE(*CPIC) +
          TNSPGM('LXITMS/TM$CPI1R')
```

This changes the name of the transaction program on SYSTEMB. All other values remain the same.

CHGJOBLBL - Change Job Label

| Change Job Label (CHGJOBLBL) | | Environment: B/I |
|--------------------------------|--------------|----------------------------------|
| Job label | _____ | |
| Data retention: | | |
| Generations | <u>*SAME</u> | 0-9999, *SAME |
| Days | <u>*SAME</u> | 0-9000, *SAME, *PERM |
| Type of information to retain: | | |
| Document library object | <u>*SAME</u> | *SAME, *BASIC, *ALL |
| Lotus Notes/Domino | <u>*SAME</u> | *SAME, *BASIC, *ALL |
| Integrated file system | <u>*SAME</u> | *SAME, *BASIC, *ALL |
| Libraries and objects | <u>*SAME</u> | *SAME, *LIB, *OBJ, *MBR, *USRDFN |
| Save files | <u>*SAME</u> | *SAME, *BASIC, *ALL, *USRDFN |
| Referenced tape pool | <u>*SAME</u> | Name, *SAME, *JOBLBL |
| System | _____ | Name, *CURRENT |
| Print volume label | <u>*NO</u> | *NO, *YES |
| Text 'description' | <u>*SAME</u> | |
| Volume Pool: | | |
| Beginning | <u>*SAME</u> | Character value, *SAME, *DEV |
| Ending | <u>*SAME</u> | Character value, *SAME, *DEV |
| Last used | <u>*SAME</u> | Character value, *SAME... |
| Usage | <u>*SAME</u> | *SAME, *DEV, *ANY, *NEXT, *LAST |
| Tape range error | <u>*SAME</u> | *SAME, *DEV, *IGNORE, *REJECT |

Purpose

The Change Job Label (CHGJOBLBL) command changes the attributes of an existing Job Label for an output (write) tape function. The Job Label establishes data retention, text, data retrieval levels, tape label printing requirements and tape pool attributes. Job Labels, if used, ensure data retention and usage consistency whenever the tape function occurs.

Job Labels can cross system boundaries. A Job Label created on one system can reference a Job Label on another system defined in the MMS/*tms* network.

Parameters

- JOBLBL: Specifies the name (up to 20-characters) of the Job Label.
- *DFT The default Job Label is changed.
- Job-label* Enter a valid Job Label.

VOLRET: Specifies the type of retention that is used for all volumes created by this Job Label. If generations *and* days are specified, the generation requirements must be met *before* the day requirements are used to determine the status of a volume.

Generation: Specifies the number of tapes that are in active status. The following precautions and recommendations should be observed when using retention by generations.

- Generations are automatically recalculated when a Job Label is changed or when a volume is added, changed to another Job Label, deleted, initialized, scratched or reused.
- Performing multiple saves using assorted Job Labels with different generations onto the same tape is not recommended. If saving multiple Job Labels to the same tape is required, use retention by days – not generations.
- Only one Job Label should be used per tape. Appending data, regardless of Job Label, is not recommended. If appending data to tapes is required, use retention by days – not generations.
- If retention by generation is used, it is recommended that retention by days also be used.

***SAME** Retain the current value.

0 No generations are required.

0-9999 Enter the number of generations required for this Job Label.

Days: Specifies the number of days that the volumes are in active (not available for use) status.

***SAME** Retain the current value.

***PERM** The tapes are permanently active.

0 - 9000 Enter a value from 0 to 9000 that defines the number of days the tapes will be active.

RTVLVL: Specifies the amount of information that is retrieved and written to the MMS/*tms* database for the various types of OS/400 file systems and related objects. The retrieval level should be based on your requirements for detailed recovery information. The retrieval level for libraries can be a global value or can be user-defined on a library by library basis.

| | |
|-----------------------|---|
| <u>DLO detail:</u> | Specifies the retrieval level for folders/documents. |
| *SAME | Retain the current value. |
| *BASIC | Saved folders and documents are not written to the database. |
| *ALL | Saved folders and documents are written to the database. |
| <u>Domino detail:</u> | Specifies the retrieval level for Lotus Notes/Domino objects. |
| *SAME | Retain the current value. |
| *BASIC | Saved Lotus Notes/Domino objects are not written to the database. |
| *ALL | Saved Lotus Notes/Domino objects are written to the database. |
| <u>IFS detail:</u> | Specifies the retrieval level for Integrated File System objects. |
| *SAME | Retain the current value. |
| *BASIC | Saved Integrated File System objects are not written to the database. |
| *ALL | Saved Integrated File System objects are written to the database. |
| <u>Object detail:</u> | Specifies the retrieval level for objects. |
| *SAME | Retain the current value. |
| *LIB | The library name is written to the database. No other information about the saved library or saved objects is available. |
| *OBJ | The library and object information is written to the database. |
| *MBR | The library, object, and member information is written to the database. |
| *USRDFN | The retrieval level is user-defined. Refer to the <i>Change Retrieval Level (CHGRTVLVL)</i> command for additional information. |

Save-file Level: Specifies if save file contents are retrieved.

| | |
|---------------------|--|
| <u>*SAME</u> | Retain the current value. |
| *BASIC | No save-file contents are written to the database when an embedded save-file is found. |
| *ALL | Save-files contents are written to the database. The contents of save-files within the first level save-files are not retrieved. |
| *USRDFN | The retrieval level is user-defined. Refer to the <i>Change Retrieval Level (CHGRTVLVL)</i> command for additional information. |

REFLBL: Specifies that this Job Label references another Job Labels tape pool information. Referencing another Job Label tape pool provides the ability to put several different Job Labels on the same tape. Job Labels cannot reference a Job Label that is referencing another Job Label. Referenced Job Labels cannot be deleted until all references have been removed.

Job Label: Specifies the name of the Job Label being referenced.

| | |
|---------------------|--------------------------------------|
| <u>*SAME</u> | Retain the current value. |
| *JOBLBL | The current Job Label is referenced. |
| <i>Job-label</i> | Enter a valid Job Label. |

System: Specifies the name of the system that contains the Job Label being referenced. The system must be defined in the MMS/*tms* network.

| | |
|------------------------|---|
| <u>*CURRENT</u> | The referenced Job Label resides on the current system. |
| <i>System-name</i> | Enter a system name. |

VOLLBL: Specifies if tape labels are printed for volumes created by this Job Label.

| | |
|---------------------|---|
| <u>*SAME</u> | Retain the current value. |
| *NO | No tape labels are printed. |
| *YES | Tape labels are printed for the volumes being used. |

TEXT: Specifies the text that briefly describes the object.

| | |
|----------------------|--|
| <u>*SAME</u> | Retain the current value. |
| <i>'description'</i> | Enter no more than 50 characters of text, enclosed in apostrophes. |

POOL: Specifies the range of volumes allowed and the action to take if a volume that is not within the user-defined range is mounted.

Beginning: Specifies the first volume in the pool range.

***SAME** Retain the current value.

***DEV** The beginning volume in the range is defined by the tape device.

Volume-id Enter the beginning volume identifier.

Ending: Specifies the last volume in the pool range.

***SAME** Retain the current value.

***DEV** The last volume in the range is defined by the tape device.

Volume-id Enter the ending volume identifier.

Last used: Specifies the last volume used.

***SAME** Retain the current value.

***AVAIL** MMS/*tms* uses the first available volume from within the range.

Volume-id Enter the last used volume identifier.

Usage: Specifies how volumes from this pool are selected.

***SAME** Retain the current value.

***DEV** The volume usage is defined by the tape device.

***ANY** Any volume within the range is accepted. This value can be used by some tape libraries. If used, it forces the tape library server to select the volume.

***NEXT** The next available volume *after* the one specified for the Last used parameter is selected. If one doesn't exist, the first available volume is selected.

***LAST** The volume specified for the Last used parameter is selected. If it doesn't exist, the first available scratch volume is selected. A scratch volume is selected if, during processing, a continuation volume is required.

| | |
|---------------------|---|
| <u>Range Error:</u> | Specifies the action to take if the tape is not within range. |
| *SAME | Retain the current value. |
| *DEV | The tape range error is defined in the tape Device Definition. |
| *IGNORE | The tape range error is ignored. |
| *REJECT | The tape is unloaded. An available scratch tape is mounted if a tape is rejected in a tape library. |

Examples

```
CHGJOB LBL JOBLBL(DAILY) VOLRET(5 0)
```

This changes a Job Label named DAILY to a retention of 5 generations and 0 days. Since generations and days are specified, the tapes remain active until the sixth run of this job. At that time, the oldest job is removed from generation control and the expiration date is used to determine the status (active/scratch) of the tape. Since 0 is specified for days, the volumes go to scratch status as soon as they are removed from the generation control. All other values would remain as specified.

```
CHGJOB LBL JOBLBL(WEEKLY) VOLRET(0 90) VOLLBL(*NO) +
INFTYPE(*SAME *SAME *SAME *MBR *ALL) +
POOL(800000 800100 800034 *NEXT *REJECT)
```

This changes a Job Label named WEEKLY to a retention of 90 days. The objects saved are tracked at member level and if a save-file is saved, its contents are retrieved. Tape labels are not printed. The tapes must be in the range of 800000 to 800100. The last volume used was 800034 and the job mounts the next available scratch tape and rejects any tape not within range.

CHGPRDOPT - Change Product Options

| Change Product Options (CHGPRDOPT) | | Environment: I |
|--|----------------|------------------|
| Product identifier | <u>*TMS</u> | *TMS |
| Default location name | <u>*DFTLOC</u> | Name, *DFTLOC |
| Default retrieval level | <u>*LIB</u> | *LIB, *OBJ, *MBR |
| Nonlabeled tape support | <u>*NO</u> | *NO, *YES |
| Local host name | <u>*NETATR</u> | Name, *NETATR |
| Local Internet address | <u>*ANY</u> | Name, *ANY |
| Local port number | <u>*NONE</u> | 1-65535, *NONE |
| Remote port number | <u>*NONE</u> | 1-65535, *NONE |
| Communications recovery wait | <u>003600</u> | 1-999999 |

Purpose

The Change Product Options (CHGPRDOPT) command defines the MMS/*tms* operating options. These options include non-labeled tape support, default data retrieval level, default location name, Internet address and port numbers. Since these options change internal processing methods, they can be changed only if MMS/*tms* is detached.

Parameters

- PRDID:** Specifies the product acronym.
- *TMS** The MMS/*tms* product.
- DFTLOCNAME:** Specifies the name of the default location. This value should be the name of the data center or location that uses the volumes being managed by MMS/*tms*. This value is used for display purposes only and does not alter any database information.
- *DFTLOC** The default location name is **DFTLOC**.
- Location* Enter up to 10-characters for the default location name.
- DFTRTVLVL:** Specifies the default retrieval level for any library whose retrieval level has not been explicitly defined.
- *LIB** The library name is written to the database. No other information about the saved library is available.
- *OBJ** The library and its objects are written to the database.
- *MBR** The library and its objects and members are written to the database.

| | |
|-------------|---|
| NONLBL: | Specifies if Non-labeled tape support is active. Non-labeled tape support prompts the user for the volume identifier when a tape without a standard label is encountered. Since tapes without labels do not have save dates or expiration dates, MMS/ <i>tms</i> defaults these values. The default save date is the current date and the default expiration date is *PERM . |
| | *NO No non-labeled tape support. |
| | *YES Non-labeled tape support. |
| LCLHOST: | Specifies the local host name to use when connecting to the remote system. |
| | *NONE No local port number is assigned. |
| | *NETATR Use the current system name value defined in the network attributes. |
| | <i>Local-host-name</i> Enter a local host name. |
| LCLINTNETA: | Specifies the local Internet address of the communication link that the out-bound data is to use. If the Internet address is entered from a command line, the address must be enclosed in apostrophes. The format of the Internet address is nnn.nnn.nnn.nnn where nnn is a decimal number ranging from 0 through 255. |
| | *ANY Any local Internet address is used. |
| | <i>Internet-address</i> Enter the Internet address of the remote (target) system. |
| LCLPORT: | Specifies the port number being used by the communications server. Note: Ports 1 through 1023 are used by system-supplied TCP/IP applications. If the user specifies one of these ports, it can affect the operation of those applications. See the assigned numbers RFC for the definition of port numbers currently used by TCP/IP applications. |
| | *NONE No local port number is assigned. |
| | <i>1-65535</i> Enter a local port number. |
| RMTPORT: | Specifies the port number being used by the remote location. Note: Ports 1 through 1023 are used by system-supplied TCP/IP applications. If the user specifies one of these ports, it can affect the operation of those applications. See the assigned numbers RFC for the definition of port numbers currently used by TCP/IP applications. |
| | *NONE No remote port number is assigned. |
| | <i>1-65535</i> Enter a remote port number. |
| WAIT: | Specifies the amount of time (in seconds) that must elapse before the Communications Recovery Manager checks for remote systems that are not responding. |
| | 003600 The Communications Recovery Manager waits 1 hour. |
| | <i>1-999999</i> Enter a value from 1 to 999999. |

Examples

`CHGPRDOPT DFTLOCNAME(*DFTLOC) DFTRTVLVL(*LIB) NONLBL(*YES)`

This changes the default location name to *DFTLOC, the default retrieval level to *LIB and adds non-labeled tape support.

CHGPRDSTS - Change Product Status

| | |
|-----------------------------------|-------------------------|
| Change Product Status (CHGPRDSTS) | Environment: B/I |
| Product identifier | *AMS, *TMS |
| Status | *ATTACH, *DETACH, *SAME |

| | |
|---------|---|
| Purpose | The Change Product Status (CHGPRDSTS) command attaches or detaches MMS/ <i>tms</i> from OS/400. The *ATTACH process installs the link between MMS/ <i>tms</i> and OS/400. Once attached, MMS/ <i>tms</i> is active and managing devices and tapes. The *DETACH process removes the link between MMS/ <i>tms</i> and OS/400. Once detached, MMS/ <i>tms</i> is inactive and no longer tracking/managing devices and tapes. |
|---------|---|

| | | | | | | | | | | | |
|--------------|---|------|------------------------------|------|------------------------------|--------------|---------------------------|---------|------------------------------|---------|-------------------------------|
| Parameters | <p>PRDID: Specifies the product acronym.</p> <table style="margin-left: 20px;"> <tr> <td>*AMS</td> <td>The MMS/<i>ams</i> product.</td> </tr> <tr> <td>*TMS</td> <td>The MMS/<i>tms</i> product.</td> </tr> </table> <p>STATUS: Specifies the status of the product.</p> <table style="margin-left: 20px;"> <tr> <td>*SAME</td> <td>Retain the current value.</td> </tr> <tr> <td>*ATTACH</td> <td>Installs the link to OS/400.</td> </tr> <tr> <td>*DETACH</td> <td>Removes the link from OS/400.</td> </tr> </table> | *AMS | The MMS/ <i>ams</i> product. | *TMS | The MMS/ <i>tms</i> product. | *SAME | Retain the current value. | *ATTACH | Installs the link to OS/400. | *DETACH | Removes the link from OS/400. |
| *AMS | The MMS/ <i>ams</i> product. | | | | | | | | | | |
| *TMS | The MMS/ <i>tms</i> product. | | | | | | | | | | |
| *SAME | Retain the current value. | | | | | | | | | | |
| *ATTACH | Installs the link to OS/400. | | | | | | | | | | |
| *DETACH | Removes the link from OS/400. | | | | | | | | | | |

| | |
|----------|---|
| Examples | <p>CHGPRDSTS PRDID(*TMS) STATUS(*ATTACH) This changes the status of MMS/<i>tms</i> to *ATTACH. This activates the link between MMS/<i>tms</i> and OS/400.</p> <p>CHGPRDSTS PRDID(*TMS) STATUS(*DETACH) This changes the status of MMS/<i>tms</i> to *DETACH. This deactivates the link between MMS/<i>tms</i> and OS/400.</p> |
|----------|---|

CHGRTVLVL - Change Retrieval Level

| Change Retrieval Level (CHGRTVLVL) | | Environment: B/I |
|------------------------------------|--------------|-------------------------|
| Library | | Name |
| Information type: | | |
| Retrieval level | <u>*SAME</u> | *SAME, *LIB, *OBJ, *MBR |
| Save file level | <u>*SAME</u> | *SAME, *NO, *YES |

Purpose

The Change Retrieval Level (CHGRTVLVL) command changes the retrieval level of a library or save-files. Changing the retrieval level to object or member provides detail information on the saved objects for recovery purposes. This level of information requires additional resources, processing time and disk space. Changing the retrieval level to library level reduces detailed saved object information but increases processing speed and minimizes disk space. Changing the retrieval level is not allowed for some IBM libraries.

Parameters

- LIBRARY:** Specifies the name of the library to change.
- Library-name* Enter a valid library name.
-
- RTVLVL:** Specifies the amount of information that is retrieved and written to the MMS/*tms* database.
- Retrieval Level: Specifies the retrieval level for libraries.
- | | |
|--------------|--|
| *SAME | Retain the current value. |
| *LIB | The library name is written to the database. No other information about the saved library is available. No save-file retrieval is allowed. Space requirements = Number of libraries * 269. |
| *OBJ | The library and its objects are written to the database. Space requirements = ((Number of Objects * 269) + 269). |
| *MBR | The library and its objects and members are written to the database. Space requirements = ((Number of Members in all Objects * 269) + (Number of Objects * 269) + 269). |

Save-file Level: Specifies the number of embedded save-files from which to retrieve object information.

- *SAME** Retain the current value.
- *NO No save-file contents are written to the database when an embedded save-file is found.
- *YES Save-files contents are written to the database. The contents of save-files within the first level save-files are not retrieved.

Examples

CHGRTVLVL LIBRARY(ACCTLIB) RTVLVL(*OBJ *YES)

This changes the retrieval level for library ACCTLIB to object level. This means that the library description, and that of every object saved from the library, is written to the database. If one of the objects saved is a save-file, it is tracked at object level (all objects within the save file are written to the database).

CHGRTVLVL LIBRARY(ACCTLIB) RTVLVL(*MBR *NO)

This changes the retrieval level for library ACCTLIB to member level. This means that the library description, and that of every object and member saved from the library, is written to the database. The contents of save files, if any, are not tracked.

CHGTAPDEV - Change Tape Device

| Change Tape Device (CHGTAPDEV) | | Environment: B/I |
|--------------------------------|-------------|-------------------------------|
| Device name | <u>SAME</u> | Name |
| Share device | <u>SAME</u> | *SAME, *NO, *YES |
| Function supported | <u>SAME</u> | *SAME, *READ, *WRITE, *ALL |
| Usage | <u>SAME</u> | *SAME, *ANY, *NEXT |
| Tape library information: | | |
| Library type | <u>SAME</u> | *SAME, *NONE, *IBM, *MTX... |
| Library device | <u>SAME</u> | Name, *SAME, *NONE |
| Destination | <u>SAME</u> | Name, *SAME, *CAS, *CNV... |
| Category: | | |
| Category name | <u>SAME</u> | *SAME, *NOSHARE, *SHARE400... |
| Category system | <u>SAME</u> | *SAME, *CURRENT,... |
| Text 'description' | <u>SAME</u> | Char, *SAME, *DEV |

Purpose

The Change Tape Device (CHGTAPDEV) command changes a tape device and its attributes. Tape device attributes include the tape densities, tape functions supported, device category, and tape library information. Only devices, which have been defined, are supported by MMS/*tms*. The existence of the tape device is verified before being changed.

Parameters

- DEV:** Specifies the name of the tape device to change.
- Device-name* Enter a valid device name.
- FUNCTION:** Specifies the tape functions supported by this Device Definition.
- *SAME** Retain the current value.
 - *ALL All tapes are tracked/managed.
 - *READ Input tapes (tapes read from) are tracked/managed.
 - *WRITE Output tapes (tapes written to) are tracked/managed.
- SHARE:** Specifies if the device is shared. A shared device is one that is varied off if its not being used. When a job needs a tape device, it is varied on, used, and then varied off again. A non-shared device remains varied on when not in use. Device sharing allows a device to be used as needed. When using an IBM tape library, *NO must be specified.
- *SAME** Retain the current value.
 - *NO The device is not shared. The device remains varied on when not in use.
 - *YES The device is shared with other systems/jobs. The device is varied off when not in use.

USAGE: Specifies how volumes from this pool are selected.

***SAME** Retain the current value.

*ANY Any volume within the range is accepted. This value can be used by some tape libraries. If used, it forces the tape library server to select the volume.

*NEXT The next available volume *after* the one specified on the Last used parameter of the Job Label is selected. If one doesn't exist, the first available volume is selected.

TAPLIB: Specifies the information required for an automated tape library.

Library type: Specifies the type of tape library.

***SAME** Retain the current value.

*NONE The device is not a tape library.

*IBM IBM tape library.

*MTX Memorex/Telex tape library.

*STKDA StorageTek direct attach tape library.

*STKLS StorageTek library station tape library.

*STKSVR StorageTek server attach tape library.

Library device: Specifies the name of the library device (tape library robot).

***SAME** Retain the current value.

*NONE No library device is associated with this tape library.

Library-device Enter the name of the library device associated with the tape library.

Destination: Specifies the destination to receive the tapes being ejected.

***SAME** Retain the current value.

*DEV For IBM Tape Libraries. The tape is placed in the convenience I/O station or storage slot within the library.

*CAS For MTX Tape Libraries. The tape is placed into the MTX cartridge access station.

*CNV For IBM Tape Libraries. The tape is placed into the IBM convenience I/O station.

*HIGHCAP For IBM Tape Libraries. The tape is placed into the IBM high capacity output station.

Destination Enter the name of the output destination.

CGY: Specifies the IBM tape category attributes.

Category name: Specifies the type of tape library.

- *SAME** Retain the current value.
- *SHARE400 The cartridges can be shared with other iSeries systems that are attached to the same device.
- *NOSHARE The cartridges can be shared with other iSeries systems that are attached to the same device.
- Category-name* Enter the IBM tape category to which the tape is added or changed.

Category system: Specifies the system to which the category belongs. The system name is obtained from the pending system name field of a Display Network Attributes (DSPNETA) command. If there is no pending system name, the current system name attribute is used.

**** Attention *****

If the system name is changed, the category information associated with all tape cartridges in library devices is not valid.

- *SAME** Retain the current value.
- *CURRENT The category belongs to the system currently running the command.
- System-name* Enter a valid system name.

TEXT: Specifies the text that briefly describes the object.

- *SAME** Retain the current value.
- *DEV The text associated with the device description is used.
- 'description'* Enter no more than 50 characters of text, enclosed in apostrophes.

Examples

CHGTAPDEV DEV(TAP01) SHARE(*YES)

This shares a device named TAP01. To complete this process, TAP01 must be varied off. This command varies it on when needed.

CHGTAPLIB - Change Tape Library

| Change Tape Library (CHGTAPLIB) | | Environment: B/I |
|---------------------------------|-------------|------------------|
| Library device | _____ | Name |
| Status | _____ | *SEQ, *RANDOM |
| Sequential mode: | | |
| To device | _____ | Name |
| To Job label | <u>*DFT</u> | Char, *DFT |
| Number of volumes | <u>10</u> | 1-999 |

Purpose

The Change Tape Library (CHGTAPLIB) command performs tape library-specific functions. Some libraries cannot communicate with the iSeries when it is in restricted state, therefore special tape library commands must be issued **prior** to using the library to ensure that it functions correctly in restricted state. Other functions provide the ability to synchronize the MMS/*tms* database with a tape library. This command is only valid for Memorex/Telex or StorageTek direct attached tape libraries.

Parameters

DEV: Specifies the name of the library device (tape library robot).

Library-device Enter the name of the library device associated with the tape library.

STATUS: Specifies the function to be performed to the tape library.

***SEQ** Starts sequential mode for Memorex/Telex and direct attached StorageTek tape libraries that require a allocated pool of volumes for restricted state processing. *This must be run interactively in the same job that is using the tape library.*

Memorex/Telex: This searches the MMS/*tms* database and creates a tape set which consists of **all** scratch volumes available in the tape library.

StorageTek: This searches the MMS/*tms* database and allocates the requested number of scratch volumes.

***RANDOM** This returns the tape library to random or library mode.

SEQMOD: Specifies the device, Job Label and number of volume to allocate for sequential mode processing. Sequential mode processing is only valid for StorageTek direct attached tape libraries.

To device: Specifies the name of the tape device to use.

Device-name Enter a valid device name.

To Job Label: Specifies the name of the Job Label to use when selecting scratch volumes.

***DFT** The default Job Label is used.

Job-label Enter a valid Job Label.

Nbr of volumes: Specifies the number of scratch volumes to allocate to this job.

10 Ten (10) scratch volumes are allocated, if available.

Number Enter the number of volumes to allocate.

Examples

CHGTAPLIB DEV(RML9710) STATUS(*SEQ) SEQMOD(TAP04 WEEKLY 25)

This changes the status of a StorageTek 9710 direct attached tape library to sequential mode. Up to 25 scratch volumes are allocated from Job Label WEEKLY to device TAP04.

CHGTAPLIB DEV(RML9710) STATUS(*RANDOM)

This ends sequential mode for a StorageTek 9710 direct attached tape library and changes the mode to random.

CHGTAPUSG - Change Tape Usage

| Change Tape Usage (CHGTAPUSG) | | Environment: B/I |
|-------------------------------|--------------|--------------------------------|
| Device | _____ | Name |
| Tape Density | _____ | *CTGTYPE, *DEVTYPE, *QIC120... |
| Initialize: | | |
| Format | <u>*SAME</u> | Character value, *SAME |
| Number | <u>*SAME</u> | Character value, *SAME |
| Allow format change | <u>*SAME</u> | *SAME, *NO, *YES |
| Tape Pool: | | |
| Beginning | <u>*SAME</u> | Character value, *SAME... |
| Ending | <u>*SAME</u> | Character value, *SAME, *END |
| Tape range error | <u>*SAME</u> | *SAME, *IGNORE, *REJECT |
| Owner | <u>*SAME</u> | Character value, *SAME... |
| + for more values | _____ | |

Purpose

The Change Tape Usage (CHGTAPUSG) command changes specific density attributes for the specified device. The attributes include the initialization format and volume range attributes.

Parameters

- DEV:** Specifies the name of the tape device whose density attributes to change.
Device-name Enter a valid device name.
- DENSITY:** Specifies the density of the device whose usage attributes to change.
- *DEVTYPE The device determined density is changed.
 - *CTGTYPE The media determined density is changed.
 - Density* Enter a density that is defined for the tape device being changed.

INZFMT: Specifies the volume identifier format and starting number for generating new volume-ids. These values are used when *GEN is specified in the NEWVOL parameter of the MMS/tms Initialize Tape (INZTAP) command. These values are also used to verify a user generated volume identifier.

Format: Specifies the format of the volume identifier. When specifying a format, the first character can be any valid character from A-Z or 0-9. This becomes the volume prefix and it is not incremented by MMS/tms. The remaining 5-positions must either be "A" for an alpha value or "N" for a numeric value. These values are incremented by MMS/tms when required. A format of "ONNNNN" specifies that the volume prefix is "O" and the remaining values are all numeric. The actual value is specified in the "Number" parameter.

***SAME** Retain the current value.

Format Enter up to six characters.

Number: Specifies the first available number to use for MMS/tms initialization. The number must match the format. If the format is "ONNNNN", the number can be "000123". A value of "0AA123" would be invalid since it does not match the format. This value is automatically incremented by MMS/tms when the number is used. If the next number to be used already exists in MMS/tms, it is bypassed until a volume identifier is found that does not exist.

***SAME** Retain the current value.

number Enter the first number to use for automatic tape initialization.

Format change: Specifies if the format specified can be overridden when validating a user-generated volume identifier.

***SAME** Retain the current value.

*NO The volume identifier must match the format.

*YES The volume identifier does not have to match the format.

POOL: Specifies the range of volumes allowed and the action to take if a volume that is not within the range is mounted.

Beginning range: Specifies the first volume in the pool range.

***SAME** Retain the current value.

*BEGIN There is no volume range limit specified for the beginning volume.

Volume-id Enter the beginning volume identifier.

Ending range: Specifies the last volume in the pool range.

***SAME** Retain the current value.

*END There is no volume range limit specified for the ending volume.

Volume-id Enter the ending volume identifier.

Range Error: Specifies the action to take if the volume is not within range.

***SAME** Retain the current value.

*IGNORE The volume is ignored by MMS/*tms*. The tape function is allowed volume information is not written to the database.

*REJECT The volume is rejected and an error message is sent to the System Operator requesting a different volume. The tape function will wait until a volume that is within range is mounted.

OWNER: Specifies the volume owners (up to 4) that are verified. If a volume is used and the volume owner does not match the owners specified in this parameter, the volume is ignored by MMS/*tms*. Volume owners are established when a tape is initialized.

***SAME** Retain the current value.

*BLANK Volumes with no owner identifier are valid.

*ANY Any volume owner is accepted.

Owner-name Enter up to four volume owners.

Examples

```
CHGTAPUSG DEV(TAP01) DENSITY(*QIC120) INZFMT(0NNNNN 010000 *YES) +
          POOL(*BEGIN *END *IGNORE) OWNER(*ANY)
```

This establishes the initialization format and device tape pool range for device TAP01 with density *QIC120. The initialization format has a length of 6 with a "0" for the prefix, followed by 5 numeric (NNNNN). The first number to generate is 010000. If the user specifies a volume identifier, the format does not have to match the one defined (0NNNNN). The device pool accepts the lowest volume number available (*BEGIN) and accepts the highest volume number available (*END). If a tape that is not within this range is mounted, it is ignored (*IGNORE). Any owner identifiers are accepted (*ANY).

```
CHGTAPUSG DEV(TAP01) DENSITY(*QIC120) INZFMT(CNNNNN C08381 *YES) +
          RANGE(C08000 C08999 *REJECT) OWNER(*ANY)
```

This establishes the initialization format and device tape pool range for device TAP01 with density *QIC120. The initialization format has a length of 6 with a "C" for the prefix, followed by 5 numeric (NNNNN). The first number to generate is C08381. If the user specifies a volume identifier, the format does not have to match the one defined (CNNNNN). The device pool accepts C08000 as the lowest volume number allowed and C08999 as the highest volume number allowed. If a volume that is not within this range is mounted, it is rejected (*REJECT). Any owner identifiers are accepted (*ANY).

CHGVOL - Change Volume

| Change Volume (CHGVOL) | | Environment: B/I |
|--------------------------------|--------------|-----------------------------|
| Volume identifier | | Character value |
| Job label | <u>*SAME</u> | Name, *SAME |
| Expiration date | <u>*SAME</u> | Date, *SAME, *JOBLBL, *PERM |
| Text 'description' | <u>*SAME</u> | |
| Update volume detail | <u>*NO</u> | *NO, *YES |

Purpose

The Change Volume (CHGVOL) command changes the attributes of the specified volume. The attributes that can be changed include the Job Label, expiration date and volume text. If the first volume of a multi-volume tape set is changed, all volumes in the tape set will reflect the same changes.

Parameters

VOL: Specifies the volume to change. If this is a multi-volume tape set, only the first volume can be changed. All other volumes, which are part of the multi-volume tape set, are changed accordingly.

Volume-id Enter the starting or only volume identifier.

JOBLBL: Specifies the Job Label for the volume. If a new Job Label is specified for the volume(s), the volume(s) is transferred from the old Job Label to the new one. If the old Job Label was generation controlled, MMS/*tms* recalculates the generations to ensure that the required number is active. If the new Job Label is generation controlled, MMS/*tms* recalculates the generations as needed.

***SAME** Retain the current value.

*NONE The volume is not associated with a Job Label.

Job-label Enter a valid Job Label.

EXPDATE: Specifies the expiration date of the volume(s). **Note:** *Changing the expiration date of a volume to a lesser value is not allowed. An error occurs if *JOBLBL is specified and the expiration date calculated from the Job Label is less than the existing date.*

***SAME** Retain the current value.

*PERM The volume(s) is permanently active.

*JOBLBL The expiration date is based on the Job Label attributes.

Expiration-date Enter a valid expiration date.

| | |
|----------------------|---|
| TEXT: | Specifies the text that briefly describes the object. |
| <u>*SAME</u> | Retain the current value. |
| *BLANK | No text is associated with this volume. |
| *JOBLBL | The text from the Job Label is used. |
| <i>'description'</i> | Enter no more than 50 characters of text, enclosed in apostrophes. |
| UPDDL: | Specifies the contents associated with the volume should have the Job Label changed to match the current Job Label of the volume. |
| <u>*NO</u> | The volume contents retain the original Job Label used. |
| *YES | The volume contents are changed to reflect the current Job Label of the volume. |

Examples

CHGVOL VOL(001000) JOBLBL('DAILY') EXPDATE(*JOBLBL)

This changes volume 001000 and all associated volumes (if this is a multi-volume save), to Job Label DAILY. The expiration date for the volume(s) is based on the Job Label. If the volume had a prior Job Label, it is transferred to the new one (DAILY). If the prior Job Labels retention was controlled by generations, they are recalculated. If the new Job Labels retention is controlled by generations, they are recalculated.

CHGVOL VOL(001000) JOBLBL('WEEKLY') EXPDATE(091503) TEXT(*JOBLBL)

This changes volume 001000 and all associated volumes (if this is a multi-volume save), to Job Label WEEKLY. The expiration date for the volume(s) will be 09/15/03. If the volume had a prior Job Label, it is transferred to the new one (WEEKLY). If the prior Job Labels retention was controlled by generations, they are recalculated. If the new Job Labels retention is controlled by generations, they are recalculated. The volume text is based on the Job Label.

CHGVOLSEC - Change Volume Security

Change Volume Security (CHGVOLSEC) Environment: B/I

Volume identifier Character value
Secured function *SAME *SAME, *NONE, *READ ...

| | |
|---------|--|
| Purpose | The Change Volume Security (CHGVOLSEC) command changes the security attributes of a volume. Volume security can be used to prohibit users from reading a tape, writing to a tape volume, or both. If the iSeries is part of a MMS/ <i>mms</i> network, the security attribute is updated on all remote (target) systems. |
|---------|--|

| | |
|------------|---|
| Parameters | <p>VOL: Specifies the volume identifier whose security attributes to change.</p> <p><i>Volume-id</i> Enter a valid volume identifier.</p> <p>SEC: Specifies the type of volume security attribute to apply.</p> <p>*SAME Retain the current value.</p> <p>*NONE No volume security.</p> <p>*READ Read security is applied. The volume can be written to but not read. Any attempt to read the volume causes an escape message to be sent to the requestor.</p> <p>*WRITE Write security is applied. The volume can be read from but not written to. Any attempt to write to the volume causes an escape message to be sent to the requestor.</p> <p>*ALL Neither reads nor writes are allowed.</p> |
|------------|---|

| | |
|----------|--|
| Examples | <p>CHGVOLSEC VOL(001000) SEC(*READ)</p> <p>This changes the security for volume 001000 to *READ. This prevents the tape from being read. Read security prevents tape operations such as CHKTAP, CPYFRMTAP, DSPTAP, RSTOBJ, etc.</p> |
|----------|--|

CHGVOLSEC VOL(001000) SEC(*WRITE)

This changes the security for volume 001000 to *WRITE. This prevents the tape from being written to. Write security prevents tape operations such as CPYTOTAP, INZTAP, SAVDLO, SAVLIB, etc.

CLRVOL - Clear Volume

| | |
|-----------------------------------|------------------|
| Clear Volume (CLRVOL) | Environment: B/I |
| Volume identifier _____ | Character value |

Purpose

The Clear Volume (CLRVOL) command removes volume contents from the MMS/*tms* database. Volume header information such as save date/time and expiration date remains intact. This command must be run on the system containing the volume contents to be removed. If volume contents reside on multiple systems in a MMS/*tms* network, the contents will only be removed from the local (source) system.

Parameters

VOL: Specifies the volume to be cleared.
 Volume-id Enter a valid volume identifier.

Examples

CLRVOL VOL(001000)
 This removes the volume contents for volume 001000 from the MMS/*tms* database. The contents are only removed from the local (source) database.

CMPVOL - Compare Volume

| Compare Volume (CMPVOL) | | Environment: B/I |
|----------------------------|------------|------------------|
| Remote location | _____ | Name |
| Update remote volume | <u>*NO</u> | *NO, *YES |

Purpose

The Compare Volume (CMPVOL) command compares the local (source) MMS/*tms* database with a remote (target) MMS/*tms* database. The remote (target) system must be defined in the MMS/*tms* network. A report is printed that lists the fields in error. An option allows you synchronize the two databases. If this option is used, the local (source) database record is compared with the remote (target) database record. If the source database record has a change date/time stamp that is greater than the remote, the remote database record is updated. If the remote database record has the greater change date/time stamp, no update occurs. The CMPVOL processes updates only from the local system to the remote. To ensure synchronization, this command should be run both ways; from the local to the remote and then from the remote to the local.

The CMPVOL command must be used when no tape functions are active on all systems (local and remote). It must also be run on one system at a time. Do not initiate this command from multiple systems at the same time. This command generates transactions to the remote system. Ensure that no communication transactions exist on any system before you run this command. To view any outstanding communication transactions, use the Work with Communication Links (WRKCMNLNK) command.

Parameters

RMTLOCNAME: Specifies the name of the remote (target) database.

Remote-location Enter a valid remote location.

UPDRMT: Specifies if the remote (target) system is updated.

***NO** No database synchronization occurs. A report is produced detailing volume differences.

*YES The remote (target) database is updated if the change date/time stamp of the local (source) system is greater than the remote (target).

Examples

CMPVOL RMTLOCNAME(SYSTEMB) UPDRMT(*NO)

This compares the volumes on the local (source) system with those on the remote (target) system named SYSTEMB. This produces a report of the discrepancies but it will not correct them.

CYCLE - Cycle Volume

| Cycle Volume (CYCLE) | | Environment: B/I |
|--------------------------|----------------|------------------------|
| Retention | <u>*JOBLBL</u> | 0-9000, *JOBLBL, *PERM |
| Job label | <u>*DFT</u> | Name, *DFT, *NONE |
| Text 'description' | <u>*JOBLBL</u> | |

Purpose

The Cycle Volume (CYCLE) command establishes the attributes for an output tape function by specifying the retention for the volumes being created or associating a Job Label with the tape function. This command is job based. The attributes specified on this command remain in affect until the job ends or until another CYCLE command is issued. If the CYCLE command refers to a Job Label, the Job Label must exist, and the retention attributes of the Job Label override the retention attributes specified on this command.

Parameters

- CYCLE:** Specifies the retention in days. If ***JOBLBL** is specified, it the retention is determined by the specified Job Label.
- *JOBLBL** The volume has a permanent retention. The volume does not expire.
 - *PERM** The volume has a permanent retention. The volume does not expire.
 - 0 - 9000** Enter a value from 0 to 9000 that defines the number of days the tapes are active.
- LABEL:** Specifies the Job Label for the volume. If specified, the retention attributes of the Job Label are used.
- *DFT** The volume is associated with the default Job Label.
 - *NONE** The volume is not associated with a Job Label.
 - Job-label* Enter a valid Job Label.
- TEXT:** Specifies the text that briefly describes the object.
- *JOBLBL** The text from the Job Label is used.
 - *BLANK** No text is associated with this volume.
 - 'description'* Enter no more than 50 characters of text, enclosed in apostrophes.

```
CYCLE CYCLE(7)
```

This establishes a 7 day retention for any save performed by this job.

```
CYCLE CYCLE(*JOBLBL) LABEL(DAILY)
```

The retention for a save performed by this job is based on the Job Label named DAILY. Job Label DAILY must exist.

```
CYCLE CYCLE(*JOBLBL) LABEL(WEEKLY) TEXT('Different Text')
```

The retention for a save performed by this job is based on the Job Label named WEEKLY. The text for the volumes is specified in this command. If the TEXT parameter specified *JOBLBL, the text would be determined by the Job Label.

```
PGM
```

```
CYCLE CYCLE(*JOBLBL) LABEL(ACCOUNTING)
SAVLIB LIB(ACCTLIB) DEV(TAP01) SEQNBR(1) ENDOPT(*UNLOAD)
CYCLE CYCLE(*JOBLBL) LABEL(PAYROLL)
SAVLIB LIB(PAYLIB) DEV(TAP01) SEQNBR(1) ENDOPT(*UNLOAD)
CYCLE CYCLE(60)
SAVLIB LIB(APLIB) DEV(TAP01) SEQNBR(1) ENDOPT(*UNLOAD)
ENDPGM
```

This program saves three libraries. The first saves' attributes are based on Job Label ACCOUNTING. The second saves' attributes are based on Job Label PAYROLL. The third save has a retention of 60 days. The Job Labels, if specified, must exist at the time that the program is run.

DLCTAPDEV - De-allocate Tape Device

Deallocate Tape Device (DLCTAPDEV) Environment: B/I

Device name _____ Name

Purpose

The De-allocate Tape Device (DLCTAPDEV) command removes the MMS/*tms* allocation lock that was applied when the tape device was allocated through the ALCTAPDEV command. This command only de-allocates tape devices allocated by you. It does not de-allocate tape devices that were allocated by other jobs. The tape device must be defined to MMS/*tms*.

Parameters

DEV: Specifies the tape device to be de-allocated.
 Device-name Enter a valid device name.

Examples

DLCTAPDEV DEV(TAP01)
 This de-allocates a tape device named TAP01. The device must have been allocated to this job by the ALCTAPDEV command.

DLTCMNLNK - Delete Communication Link

Delete Communication Link (DLTCMNLNK) Environment: B/I

Remote location _____ Name

Purpose

The Delete Communication Link (DLTCMNLNK) command deletes an existing communication link between the local (source) and remote (target) system. The delete process removes all pending communication transactions. Active links cannot be deleted.

Parameters

RMTLOCNAME: Specifies the remote location to be deleted.

Remote-location Enter a valid remote location.

Examples

DLTCMNLNK RMTLOCNAME (SYSTEMB)

This deletes the communication link entry for remote (target) location SYSTEMB.

DLTJOBLBL - Delete Job Label

```

-----
Delete Job Label (DLTJOBLBL)           Environment: B/I
Job label .....                      Name
-----

```

Purpose

The Delete Job Label (DLTJOBLBL) command deletes a Job Label from the MMS/*tms* database. All volumes associated with the Job Label retain the Job Label name. If the Job Label uses retention by generations, the generations are removed and the status of the volume(s) are based on the expiration date.

Parameters

JOBLBL: Specifies the name of the Job Label to delete. The default Job Label cannot be deleted.

Job-label Enter a valid Job Label.

Examples

DLTJOBLBL JOBLBL(DAILY)

This deletes the Job Label named DAILY. All tapes, which were created with Job Label DAILY, retain the Job Label name. All generation controlled tapes are controlled by the expiration date.

DLTRTVLVL - Delete Retrieval Level

Delete Retrieval Level (DLTRTVLVL) Environment: B/I

Library _____ Name

Purpose

The Delete Retrieval Level (DLTRTVLVL) command deletes the retrieval level for a library.

Parameters

LIBRARY: Specifies the name of the library to delete.
Library-name Enter a valid library name.

Examples

DLTRTVLVL LIBRARY (ACCTLIB)
This deletes the retrieval level entry for library ACCTLIB.

DLTTAPDEV - Delete Tape Device

Delete Tape Device (DLTTAPDEV)

Environment: B/I

Device name

_____ Name

Purpose

The Delete Tape Device (DLTTAPDEV) deletes a MMS/*tms* tape Device Definition. The tape usage information, which is used by the initialization and tape pool routines, is also deleted.

Parameters

DEV: Specifies the tape Device Definition to be deleted.
Device-name Enter a valid device name.

Examples

DLTTAPDEV DEV(TAP01)
This deletes the Device Definition and tape usage attributes for device TAP01.

DLTVOL - Delete Volume

| | |
|-----------------------------------|------------------|
| Delete Volume (DLTVOL) | Environment: B/I |
| Volume identifier _____ | Character value |

Purpose

The Delete Volume (DLTVOL) command deletes a volume and its' contents from the MMS/*tms* database. If the iSeries is part of a MMS/*tms* network, the remotes (targets) will also have the volume and any contents, if available, deleted from them.

Parameters

VOL: Specifies the volume identifier to delete.
Volume-id Enter a valid volume identifier.

Examples

DLTVOL VOL(001000)
This deletes volume 001000 from the local (source) and remote (target) MMS/*tms* databases.

DSPCMNLNK - Display Communication Link

```

-----
Display Communication Link (DSPCMNLNK)      Environment:  I
Remote location .....                      Name
Output .....                               *, *PRINT
-----
    
```

Purpose

The Display Communication Link (DSPCMNLNK) displays specific MMS/*tms* remote communication link information such as communication type, local and remote location, device, transaction program, platform, Internet address and port numbers.

Parameters

RMTLOCNAME: Specifies the name of the remote (target) location to select.

Remote-location Enter a valid remote location.

OUTPUT: Specifies whether the output from the command is displayed at the requesting workstation or printed with the job's spooled output.

***** The output is displayed (if requested by an interactive job) or printed with the job's spooled output (if requested by a batch job).

***PRINT** The output is printed with the job's spooled output.

Examples

DSPCMNLNK RMTLOCNAME (*ALL)

This displays the Display Communication Link panel. The list displays configuration information about the specified communication link.

DSPJOBLBL - Display Job Label

| Display Job Label (DSPJOBLBL) | | Environment: B/I |
|-------------------------------|-------------|------------------|
| Job label | <u>*ALL</u> | Name, *ALL, *DFT |
| System name | <u>*LCL</u> | Name, *LCL |
| Output | <u>*</u> | *, *PRINT |

| | |
|---------|--|
| Purpose | The Display Job Label (DSPJOBLBL) command shows the Job Label and its' attributes. The attributes include data retention, volume text, data retrieval level, and tape pools. The information can be printed or selected on a display device. Additional information, including a list of the volumes using the Job Label can be displayed. |
|---------|--|

| | |
|------------|--|
| Parameters | <p>JOBLBL: Specifies the Job Label to select.</p> <p><u>*ALL</u> All Job Labels are selected.</p> <p>*DFT The default Job Label is selected.</p> <p><i>Job-label</i> Enter a valid Job Label.</p> <p>SYSTEM: Specifies the local (source) or remote (target) system to select. If a remote (target) system is specified, a communication link to the specified system is created. The remote (target) system definition must exist in MMS/<i>tms</i>.</p> <p><u>*LCL</u> The local system is selected.</p> <p><i>System-name</i> Enter a valid system name.</p> <p>OUTPUT: Specifies whether the output from the command is displayed at the requesting workstation or printed with the job's spooled output.</p> <p><u>*</u> The output is displayed (if requested by an interactive job) or printed with the job's spooled output (if requested by a batch job).</p> <p>*PRINT The output is printed with the job's spooled output.</p> |
|------------|--|

| | |
|----------|--|
| Examples | <p>DSPJOBLBL JOBLBL(*ALL) This displays all Job Labels.</p> |
|----------|--|

DSPJOBLBL JOBLBL(DAILY) SYSTEM(SYSTEMB)
This displays Job Label DAILY on SYSTEMB.

DSPSAVDLO - Display Saved DLO

| Display Saved DLO (DSPSAVDLO) | | Environment: B/I |
|----------------------------------|-----------------|-------------------------|
| Path name | / _____ | Name, *NONE, / |
| Time period for volume output: | | |
| Starting date and time: | | |
| Beginning date | <u>*BEGIN</u> | Date, *CURRENT, *BEGIN |
| Beginning time | <u>*AVAIL</u> | Time, *AVAIL |
| Ending date and time: | | |
| Ending date | <u>*CURRENT</u> | Date, *CURRENT |
| Ending time | <u>*AVAIL</u> | Time, *AVAIL |
| Job label | <u>*LCL</u> | Name, *LCL |
| System name | <u>*ALL</u> | Name, *ALL, *DFT, *NONE |
| Output | <u>*</u> | *, *PRINT, *OUTFILE |
| File to receive output | | |
| Library | <u>*LIBL</u> | Name, *LIBL |
| Output member options: | | |
| Member to receive output | <u>*FIRST</u> | Name, *FIRST |
| Replace or add records | <u>*REPLACE</u> | *REPLACE, *ADD |

| | |
|---------|--|
| Purpose | The Display Saved Document Library Objects (DSPSAVDLO) command lists saved document library objects (DLO) based on user-defined selection criteria. The information includes the document library object type, description, create date, path, save date/time, volume and sequence. The information can be printed, displayed or written to an output file. Additional information, including volume information can be displayed. |
|---------|--|

| | |
|------------|--|
| Parameters | <p>PATH: Specifies the path name of the document library object.</p> <p>/ All objects from the home directory are selected.</p> <p>*NONE Documents that do not reside in a folder are selected.</p> <p><i>Path-name</i> Enter a valid path name.</p> |
|------------|--|

PERIOD: Specifies the period of time for which the saved DLO data are selected. This parameter contains two lists of two elements each.

Beginning date: One of the following is used to specify the starting date on which or after which the data must have been logged. Any DLO saved before the specified date are not selected.

***BEGIN** The logged data from the beginning of the MMS/*tms* database is selected.

***CURRENT** The logged data for the current day and between the specified starting and ending times (if specified) is selected.

Begin-date Enter the beginning date. The date must be specified in the job date format.

Beginning time: One of the following is used to specify the starting time at which or after which the data must have been logged. Any DLO saved before the specified time and date are not selected.

***AVAIL** The logged data that is available for the specified beginning date is selected.

Begin-time Enter the beginning time for the specified beginning date that determines the logged data to be selected. The time is specified in 24-hour format and can be specified with or without a time separator.

Ending date: One of the following is used to specify the ending date before which or on which the data must have been logged. Any DLO saved after the specified date are not selected.

***CURRENT** The last day on which data was logged is the last day for which the logged data is selected.

End-date Enter the ending date for which logged data is selected. The date must be specified in the job date format.

Ending time: One of the following is used to specify the ending time before which the data must have been logged. Any DLO saved after the specified time and date are not selected.

***AVAIL** The logged data that is available for the specified ending date is selected.

End-time Enter the ending time for the specified ending date that determines the logged data to be selected. The time is specified in 24-hour format and can be specified with or without a time separator.

| | |
|----------|--|
| JOBLBL: | Specifies the Job Label of the document library objects to select. |
| | *ALL All Job Labels are selected. |
| | <i>Job-label</i> Enter a valid Job Label. |
| SYSTEM: | Specifies the local (source) or remote (target) system to select. If a remote (target) system is specified, a communication link to the specified system is created. The remote (target) system definition must exist in MMS/ <i>tms</i> . |
| | *LCL The local system is selected. |
| | <i>System-name</i> Enter a valid system name. |
| OUTPUT: | Specifies whether the output from the command is displayed at the requesting workstation or printed with the job's spooled output. |
| | * The output is displayed (if requested by an interactive job) or printed with the job's spooled output (if requested by a batch job). |
| | *PRINT The output is printed with the job's spooled output. |
| | *OUTFILE The output is directed to the database output file specified on the "File to receive output" prompt (OUTFILE parameter). |
| OUTFILE: | Specifies the name and library of the database output file to which the output of the command is directed. If the file does not exist, this command creates a database output file in the specified library. |
| | <u>File to receive output:</u> |
| | <i>File-name</i> Enter the name of the database file where the output is directed. |
| | <u>Library:</u> |
| | *LIBL Searches all libraries in the job's library list until the first match is found for the value in the OUTFILE field. If the file does not exist, it is created in the QGPL library. |
| | <i>Library-name</i> Enter a valid library name. |

OUTMBR: Specifies the name of the database file member that receives the output of the command.

Members to receive output:

***FIRST**

The first member in the file receives the output. If no members exist in the file, the system creates a member with the name of the file specified in the “File to receive output” prompt (**OUTFILE** parameter).

Member-name

Enter the name of the file member that receives the output. If the name does not exist, the system creates it.

Replace or add records:

***REPLACE**

The output data replaces any existing records in the specified file member.

***ADD**

The output data is added to the end of existing records in the specified file member.

Examples

```
DSPSAVDLO  PATH(/) PERIOD((080104) (090104)) OUTPUT(*OUTFILE) +  
           OUTFILE(QTEMP/USRFILE)
```

This selects all DLO from the home directory that were saved between 08/01/04 and 09/01/04 and writes it to a file named USRFILE in library QTEMP. If the file does not exist, the command creates it.

DSPSAVLNK - Display Saved Link

| Display Saved Link (DSPSAVLNK) | | Environment: B/I |
|----------------------------------|-----------------|------------------------|
| Object name | / _____ | Name |
| Time period for volume output: | | |
| Starting date and time: | | |
| Beginning date | <u>*BEGIN</u> | Date, *CURRENT, *BEGIN |
| Beginning time | <u>*AVAIL</u> | Time, *AVAIL |
| Ending date and time: | | |
| Ending date | <u>*CURRENT</u> | Date, *CURRENT |
| Ending time | <u>*AVAIL</u> | Time, *AVAIL |
| Job label | <u>*ALL</u> | Name, *ALL |
| System name | <u>*LCL</u> | Name, *LCL |
| Output | * | *, *PRINT, *OUTFILE |
| File to receive output | | |
| Library | <u>*LIBL</u> | Name, *LIBL |
| Output member options: | | |
| Member to receive output | <u>*FIRST</u> | Name, *FIRST |
| Replace or add records | <u>*REPLACE</u> | *REPLACE, *ADD |

Purpose

The Display Saved Link (DSPSAVLNK) command shows saved links based on user-defined selection criteria. The information includes the object link, save date/time, Job Label, volume and sequence. The information can be printed, displayed or written to an output file. Additional information, including volume information can be displayed.

Parameters

- OBJ: Specifies the path name of the saved link.
- / All objects from the home directory are selected.
- Object-name* Enter a valid object name.

PERIOD: Specifies the period of time for which the saved link data is selected. This parameter contains two lists of two elements each.

Beginning date: One of the following is used to specify the starting date on which or after which the data must have been logged. Any objects saved before the specified date are not selected.

***BEGIN** The logged data from the beginning of the MMS/*tms* database is selected.

***CURRENT** The logged data for the current day and between the specified starting and ending times (if specified) is selected.

Begin-date Enter the beginning date. The date must be specified in the job date format.

Beginning time: One of the following is used to specify the starting time at which or after which the data must have been logged. Any objects saved before the specified time and date are not selected.

***AVAIL** The logged data that is available for the specified beginning date is selected.

Begin-time Enter the beginning time for the specified beginning date that determines the logged data to be selected. The time is specified in 24-hour format and can be specified with or without a time separator.

Ending date: One of the following is used to specify the ending date before which or on which the data must have been logged. Any objects saved after the specified date are not selected.

***CURRENT** The last day on which data was logged is the last day for which the logged data is selected.

End-date Enter the ending date for which logged data is selected. The date must be specified in the job date format.

Ending time: One of the following is used to specify the ending time before which the data must have been logged. Any objects saved after the specified time and date are not selected.

***AVAIL** The logged data that is available for the specified ending date is selected.

End-time Enter the ending time for the specified ending date that determines the logged data to be selected. The time is specified in 24-hour format and can be specified with or without a time separator.

| | |
|----------|--|
| JOBLBL: | Specifies the Job Label used to save the link. |
| | *ALL All Job Labels are selected. |
| | <i>Job-label</i> Enter a valid Job Label. |
| SYSTEM: | Specifies the local (source) or remote (target) system to select. If a remote (target) system is specified, a communication link to the specified system is created. The remote (target) system definition must exist in MMS/ <i>tms</i> . |
| | *LCL The local system is selected. |
| | <i>System-name</i> Enter a valid system name. |
| OUTPUT: | Specifies whether the output from the command is displayed at the requesting workstation or printed with the job's spooled output. |
| | * The output is displayed (if requested by an interactive job) or printed with the job's spooled output (if requested by a batch job). |
| | *PRINT The output is printed with the job's spooled output. |
| | *OUTFILE The output is directed to the database output file specified on the "File to receive output" prompt (OUTFILE parameter). |
| OUTFILE: | Specifies the name and library of the database output file to which the output of the command is directed. If the file does not exist, this command creates a database output file in the specified library. |
| | <u>File to receive output:</u> |
| | <i>File-name</i> Enter the name of the database file where the output is directed. |
| | <u>Library:</u> |
| | *LIBL Searches all libraries in the job's library list until the first match is found for the value in the OUTFILE field. If the file does not exist, it is created in the QGPL library. |
| | <i>Library-name</i> Enter a valid library name. |

OUTMBR: Specifies the name of the database file member that receives the output of the command.

Members to receive output:

***FIRST**

The first member in the file receives the output. If no members exist in the file, the system creates a member with the name of the file specified in the “File to receive output” prompt (**OUTFILE** parameter).

Member-name

Enter the name of the file member that receives the output. If the name does not exist, the system creates it.

Replace or add records:

***REPLACE**

The output data replaces any existing records in the specified file member.

***ADD**

The output data is added to the end of existing records in the specified file member.

Examples

DSPSAVLNK

This displays all saved links.

DSPSAVLNK OBJ(dev) PERIOD((080104)) OUTPUT(*PRINT)

This prints the link named “dev” and was saved from 08/01/04 to the current date.

DSPSAVOBJ - Display Saved Object

| Display Saved Object (DSPSAVOBJ) | | Environment: B/I |
|----------------------------------|-----------------|------------------------|
| Object name | <u>*ALL</u> | Name, *ALL |
| Library | <u>*ALL</u> | Name, *ALL |
| Object type | <u>*ALL</u> | Char, *ALL |
| Time period for volume output: | | |
| Starting date and time: | | |
| Beginning date | <u>*BEGIN</u> | Date, *CURRENT, *BEGIN |
| Beginning time | <u>*AVAIL</u> | Time, *AVAIL |
| Ending date and time: | | |
| Ending date | <u>*CURRENT</u> | Date, *CURRENT |
| Ending time | <u>*AVAIL</u> | Time, *AVAIL |
| Job label | <u>*ALL</u> | Name, *ALL |
| System name | <u>*LCL</u> | Name, *LCL |
| Output | <u>*</u> | *, *PRINT, *OUTFILE |
| File to receive output | <u>_____</u> | |
| Library | <u>*LIBL</u> | Name, *LIBL |
| Output member options: | | |
| Member to receive output | <u>*FIRST</u> | Name, *FIRST |
| Replace or add records | <u>*REPLACE</u> | *REPLACE, *ADD |

Purpose

The Display Saved Object (DSPSAVOBJ) command shows saved objects based on user-defined selection criteria. The information includes the library, object type, attribute, save command, save date/time, volume and sequence. The information can be printed or selected on a display device. Additional information, including volume information can be displayed. Only the base volume is shown if the object being displayed/printed spans multiple volumes. To view all tapes associated with the save, use **Option 5** to display the volumes.

Parameters

OBJ: Specifies the name of the saved object.

Object:

- *ALL All saved objects are selected.
- generic* Enter the generic name of the objects to be selected. A generic name is a character string that contains one or more characters followed by an asterisk (*).
- Object-name* Enter a valid object name.

Library:

- *ALL All saved libraries in are selected.
- Library-name* Enter a valid library name.

OBJTYPE: Specifies which type of objects to select.

***ALL** All object types are selected.

Object-type Enter the object type for the objects to be selected, such as ***CMD**, ***FILE** or ***PGM**.

PERIOD: Specifies the period of time for which the saved object data is selected. This parameter contains two lists of two elements each.

Beginning date: One of the following is used to specify the starting date on which or after which the data must have been logged. Any objects saved before the specified date are not selected.

***BEGIN** The logged data from the beginning of the MMS/*tms* database is selected.

***CURRENT** The logged data for the current day and between the specified starting and ending times (if specified) is selected.

Begin-date Enter the beginning date. The date must be specified in the job date format.

Beginning time: One of the following is used to specify the starting time at which or after which the data must have been logged. Any objects saved before the specified time and date are not selected.

***AVAIL** The logged data that is available for the specified beginning date is selected.

Begin-time Enter the beginning time for the specified beginning date that determines the logged data to be selected. The time is specified in 24-hour format and can be specified with or without a time separator.

Ending date: One of the following is used to specify the ending date before which or on which the data must have been logged. Any objects saved after the specified date are not selected.

***CURRENT** The last day on which data was logged is the last day for which the logged data is selected.

End-date Enter the ending date for which logged data is selected. The date must be specified in the job date format.

| | | |
|---------|----------------------|--|
| | <u>Ending time:</u> | One of the following is used to specify the ending time before which the data must have been logged. Any objects saved after the specified time and date are not selected. |
| | <u>*AVAIL</u> | The logged data that is available for the specified ending date is selected. |
| | <i>End-time</i> | Enter the ending time for the specified ending date that determines the logged data to be selected. The time is specified in 24-hour format and can be specified with or without a time separator. |
| JOBLBL: | | Specifies the Job Label of the volume(s) to select. |
| | <u>*ALL</u> | All Job Labels are selected. |
| | <i>Job-label</i> | Enter a valid Job Label. |
| SYSTEM: | | Specifies the local (source) or remote (target) system to select. If a remote (target) system is specified, a communication link to the specified system is created. The remote (target) system definition must exist in MMS/ <i>tms</i> . |
| | <u>*LCL</u> | The local system is selected. |
| | <i>System-name</i> | Enter a valid system name. |
| OUTPUT: | | Specifies whether the output from the command is displayed at the requesting workstation or printed with the job's spooled output. |
| | <u>*</u> | The output is displayed (if requested by an interactive job) or printed with the job's spooled output (if requested by a batch job). |
| | *PRINT | The output is printed with the job's spooled output. |
| | *OUTFILE | The output is directed to the database output file specified on the "File to receive output" prompt (OUTFILE parameter). |

OUTFILE: Specifies the name and library of the database output file to which the output of the command is directed. If the file does not exist, this command creates a database output file in the specified library.

File to receive output:

File-name Enter the name of the database file where the output is directed.

Library:

***LIBL** Searches all libraries in the job's library list until the first match is found for the value in the **OUTFILE** field. If the file does not exist, it is created in the **QGPL** library.

Library-name Enter a valid library name.

OUTMBR: Specifies the name of the database file member that receives the output of the command.

Members to receive output:

***FIRST** The first member in the file receives the output. If no members exist in the file, the system creates a member with the name of the file specified in the "File to receive output" prompt (**OUTFILE** parameter).

Member-name Enter the name of the file member that receives the output. If the name does not exist, the system creates it.

Replace or add records:

***REPLACE** The output data replaces any existing records in the specified file member.

***ADD** The output data is added to the end of existing records in the specified file member.

Examples

DSPSAVOBJ
This displays all saved objects.

DSPSAVOBJ OBJ(ACC*) PERIOD((080104)) OUTPUT(*PRINT)
This prints all objects that start with ACC and were saved from 08/01/04 to the current date.

DSPSAVOBJ OBJ(ACCTLIB/ACC*) OBJTYPE(*FILE) PERIOD((080104) + (090104)) OUTPUT(*OUTFILE) OUTFILE(QTEMP/USRFILE)
This writes all objects, saved from ACCTLIB, that start with ACC and are a *FILE, and were saved between 08/01/04 and 09/01/04, to a file named USRFILE in library QTEMP. If the file does not exist, the command creates it.

DSPVOL - Display Volume

| Display Volume (DSPVOL) | | Environment: B/I |
|--------------------------------|-----------------|---------------------------|
| Volume identifier | <u>*ALL</u> | Character value, *ALL |
| Location name | <u>*ALL</u> | Character value, *ALL |
| Volume Status | <u>*ALL</u> | *ALL, *ACT, *ERR, *GEN... |
| Time period for volume output: | | |
| Starting date and time: | | |
| Beginning date | <u>*BEGIN</u> | Date, *CURRENT, *BEGIN |
| Beginning time | <u>*AVAIL</u> | Time, *AVAIL |
| Ending date and time: | | |
| Ending date | <u>*CURRENT</u> | Date, *CURRENT, *END |
| Ending time | <u>*AVAIL</u> | Time, *AVAIL |
| Job label | <u>*ALL</u> | |
| Text 'description' | <u>*ALL</u> | |
| System name | <u>*ALL</u> | Name, *LCL, *ALL |
| Output | <u>*</u> | *, *PRINT, *OUTFILE |
| File to receive output | | |
| Library | <u>*LIBL</u> | Name, *LIBL |
| Output member options: | | |
| Member to receive output | <u>*FIRST</u> | Name, *FIRST |
| Replace or add records | <u>*REPLACE</u> | *REPLACE, *ADD |
| Volume contents | <u>*NO</u> | *NO, *YES |

Purpose

The Display Volume (DSPVOL) command shows volumes based on user-defined selection criteria. The information includes the save date/time, status, text, Job Label, retention, expiration date and system. The information can be printed or shown on a display device. Additional volume information, including volume contents can be displayed.

The DSPVOL command can also be used to forecast scratch volumes. If the ending date is greater than the current date and a status of ***SCR** is specified, MMS/*tms* will show all volumes which scratch between the beginning and ending dates specified.

Parameters

- VOL:** Specifies the volume identifier(s) to select.
- *ALL All volume identifiers are selected.
 - Volume-id* Enter a valid volume identifier.
- LOC:** Specifies the volume location to select.
- *ALL All volumes, regardless of location, are selected.
 - Location-name* Enter a valid location name.

STATUS: Specifies the status of the volumes to select.

***ALL** All volumes, regardless of status, are selected.

*ACT Active volumes are selected.

*ERR Error volumes are selected. Error volumes are created when a save ends abnormally and the data is incomplete.

*GEN Generation volumes are selected. Generation volumes are active volumes using retention by generation.

*SCR Scratch volumes are selected. Scratch volumes are available for use.

*SEC Secured volumes are selected. Secured volumes have volume security applied to them.

PERIOD: Specifies the period of time for which the volume data is selected. This parameter contains two lists of two elements each.

Beginning date: One of the following is used to specify the starting date on which or after which the data must have been logged. Any volumes saved before the specified date are not selected.

***BEGIN** The logged data from the beginning of the MMS/*tms* database is selected.

*CURRENT The logged data for the current day and between the specified starting and ending times (if specified) is selected.

Begin-date Enter the beginning date. The date must be specified in the job date format.

Beginning time: One of the following is used to specify the starting time at which or after which the data must have been logged. Any volumes saved before the specified time and date are not selected.

***AVAIL** The logged data that is available for the specified beginning date is selected.

Begin-time Enter the beginning time for the specified beginning date that determines the logged data to be selected. The time is specified in 24-hour format and can be specified with or without a time separator.

Ending date: One of the following is used to specify the ending date before which or on which the data must have been logged. Any volumes saved after the specified date are not selected.

***CURRENT** The last day on which data was logged is the last day for which the logged data is selected.

***END** Lists all volumes that are not generation controlled.

End-date Enter the ending date for which logged data is selected. If ***SCR** is specified in the **STATUS** parameter, and a date greater than today's date is entered, MMS/*tms* lists all volumes that will be scratch by the specified end date. The date must be specified in the job date format.

Ending time: One of the following is used to specify the ending time before which the data must have been logged. Any volumes saved after the specified time and date are not selected.

***AVAIL** The logged data that is available for the specified ending date is selected.

End-time Enter the ending time for the specified ending date that determines the logged data to be selected. The time is specified in 24-hour format and can be specified with or without a time separator.

JOBLBL: Specifies the Job Label of the volume(s) to select.

***ALL** All volumes, regardless of Job Label, are selected.

***NONE** All volumes not associated with a Job Label are selected.

***DFT** All volumes associated with the default Job Label are selected.

Job-label Enter a valid Job Label.

TEXT: Specifies the volume text of the volume(s) to select.

***ALL** All volumes, regardless of text, are selected.

*generic** Enter the generic text of the volumes to be selected. A generic name is a character string that contains one or more characters followed by an asterisk (*).

'description' Enter no more than 50 characters of text, enclosed in apostrophes.

SYSTEM: Specifies the local (source) or remote (target) system to select. If a remote (target) system is specified, a communication link to the specified system is created. The remote (target) system definition must exist in MMS/*tms*.

***LCL** The local system is selected.

System-name Enter a valid system name.

OUTPUT: Specifies whether the output from the command is displayed at the requesting workstation or printed with the job's spooled output.

***** The output is displayed (if requested by an interactive job) or printed with the job's spooled output (if requested by a batch job).

*PRINT The output is printed with the job's spooled output.

*OUTFILE The output is directed to the database output file specified on the "File to receive output" prompt (**OUTFILE** parameter).

OUTFILE: Specifies the name and library of the database output file to which the output of the command is directed. If the file does not exist, this command creates a database output file in the specified library.

File to receive output:

File-name Enter the name of the database file where the output is directed.

Library:

***LIBL** Searches all libraries in the job's library list until the first match is found for the value in the **OUTFILE** field. If the file does not exist, it is created in the **QGPL** library.

Library-name Enter a valid library name.

OUTMBR: Specifies the name of the database file member that receives the output of the command.

Member to receive output:

***FIRST** The first member in the file receives the output. If no members exist in the file, the system creates a member with the name of the file specified in the "File to receive output" prompt (**OUTFILE** parameter).

Member-name Enter the name of the file member that receives the output. If the name does not exist, the system creates it.

Replace or add records:

| | |
|------------------------|---|
| <u>*REPLACE</u> | The output data replaces any existing records in the specified file member. |
| *ADD | The output data is added to the end of existing records in the specified file member. |

CONTENTS: Specifies if the selected volume contents should be printed when **OUTPUT(*PRINT)** is specified. If the volume contents reside on a remote system, they are retrieved and printed.

| | |
|-------------------|----------------------------------|
| <u>*NO</u> | Volume contents are not printed. |
| *YES | Volumes contents are printed. |

Examples

DSPVOL
This displays all volumes.

```
DSPVOL VOL(*ALL) PERIOD((080104) (090104)) JOBLBL(DAILY) +
      SYSTEM(SYSTEMB) OUTPUT(*PRINT)
```

This prints all volumes that were saved from 08/01/04 to 09/01/04, and were created on SYSTEMB with Job Label DAILY.

```
DSPVOL VOL(*ALL) PERIOD((090104)) JOBLBL(WEEKLY) +
      OUTPUT(*OUTFILE) OUTFILE(QTEMP/USRFILE)
```

This writes all volumes that were saved from 09/01/04 through today, and were created with Job Label WEEKLY, to a file named USRFILE in library QTEMP. If the file does not exist, the command creates it.

```
DSPVOL VOL(*ALL) STATUS(*SCR)
```

This displays all scratch volumes in volume identifier sequence.

```
DSPVOL VOL(*ALL) STATUS(*SCR) PERIOD((080104) (020105))
```

This displays all volumes that are or will be in scratch status between 08/01/04 and 02/01/05.

DSPVOLDTA - Display Volume Data

| Display Volume Data (DSPVOLDTA) | | Environment: B/I |
|---------------------------------|-------------|------------------|
| Volume identifier | _____ | Character value |
| System name | <u>*ALL</u> | Name, *ALL, *LCL |
| Output | * | *, *PRINT |

| Purpose |
|---|
| The Display Volume Data (DSPVOLDTA) command lists the contents of a volume. The retrieval level of the library saved determines the degree of information selected. If the library was saved with *LIB specified as the retrieval level, only the library name will be available. If the library was saved with *OBJ or *MBR retrieval level, the amount of detail information increases. |

| Parameters |
|---|
| <p>VOL: Specifies the volume identifier whose contents are selected.</p> <p><i>Volume-id</i> Enter a valid volume identifier.</p> |
| <p>SYSTEM: Specifies if all, local (source) or remote (target) systems are selected when viewing saved data. If a remote (target) system is specified, a communication link to the specified remote (target) system must exist in MMS/<i>tms</i>.</p> <p>*ALL All systems are selected.</p> <p>*LCL The local system is selected.</p> <p><i>System-name</i> Enter a valid system name.</p> |
| <p>OUTPUT: Specifies whether the output from the command is displayed at the requesting workstation or printed with the job's spooled output.</p> <p>* The output is displayed (if requested by an interactive job) or printed with the job's spooled output (if requested by a batch job).</p> <p>*PRINT The output is printed with the job's spooled output.</p> |

| Examples |
|---|
| <p>DSPVOLDTA VOL(001000) This displays the contents for volume 001000.</p> |

DSPVOLDTA VOL(001000) OUTPUT(*PRINT)
This prints the contents for volume 001000.

DSPVOLFMT - Display Volume Format

| | |
|-----------------------------------|----------------------------|
| Display Volume Format (DSPVOLFMT) | Environment: B/I |
| Tape density | *ALL, *UNKNOWN, *QIC120... |
| Device name | Name, *ALL |
| Output | *, *PRINT |

Purpose

The Display Volume Format (DSPVOLFMT) command lists the format of volumes based on device, density or both. Information includes the volume class, code, last used device and system.

Parameters

- DENSITY:** Specifies the densities of the volumes to select.
- *ALL** All volume densities are selected.
 - *UNKNOWN** Volumes with unknown densities are selected.
 - Density* Enter a valid density.
- DEV:** Specifies the device that last used the volumes to select.
- *ALL** All devices are selected.
 - Device-name* Enter a valid device name.
- OUTPUT:** Specifies whether the output from the command is displayed at the requesting workstation or printed with the job's spooled output.
- *** The output is displayed (if requested by an interactive job) or printed with the job's spooled output (if requested by a batch job).
 - *PRINT** The output is printed with the job's spooled output.

Examples

DSPVOLFMT DENSITY (*UNKNOWN) DEV(TAPMLB02)
 This displays all volumes whose density is unknown by MMS/*tms* and which were last used on device TAPMLB02.

DSPVOLINF - Display Volume Information

Display Volume Information (DSPVOLINF) Environment: B/I

Volume identifier _____ Character value
Output * *PRINT

Purpose

The Display Volume Information (DSPVOLINF) command shows all volume information available in MMS/*tm*. The information selected includes initialization date/time, tape format, save date/time, density, locate date/time, and container/slot.

Parameters

VOL: Specifies the volume identifier whose information to select.
Volume-id Enter a volume identifier.

OUTPUT: Specifies whether the output from the command is displayed at the requesting workstation or printed with the job's spooled output.

***** The output is displayed (if requested by an interactive job) or printed with the job's spooled output (if requested by a batch job).

***PRINT** The output is printed with the job's spooled output.

Examples

DSPVOLINF VOL(001000)
This displays volume information for volume 001000.

DSPVOLINF VOL(001000) OUTPUT(*PRINT)
This prints volume information for volume 001000.

DUPVOL - Duplicate Volume

| Duplicate Volume (DUPVOL) | | Environment: B/I |
|---------------------------------|------------------|-----------------------------|
| From volume | _____ | Char, *JOBLBL |
| From device | <u>*FROMVOL</u> | Name, *FROMVOL |
| From sequence number: | | |
| Starting file sequence number . | <u>*ALL</u> | 1-16777215, *ALL |
| Ending file sequence number . | _____ | |
| From Job label | <u>*DFT</u> | Name, *DFT |
| To device | _____ | Name |
| To sequence number | <u>*FROMSEQ</u> | 1-16777215, *END, *FROMSEQ |
| To Job label | <u>*FROMVOL</u> | Name, *FROMVOL |
| Volumes to eject | <u>*NONE</u> | *NONE, *COPY, *SAVE |
| Tape density | <u>*CTGTYPE</u> | *DEVTYPE, *CTGTYPE, *QIC120 |
| Data compaction | <u>*FROMFILE</u> | *FROMFILE, *YES, *NO |
| Files to duplicate | <u>*ALL</u> | *ALL, *ACTIVE |

Purpose

The Duplicate Volume (DUPVOL) command duplicates the volumes based on volume identifier or Job Label. If the volumes being duplicated are part of a multi-volume set, only the volume containing the starting file sequence number needs to be specified. MMS/*tms* will mount the additional volumes as required for the duplication process. If duplicating tapes based on a Job Label, the specified Job Label can be duplicated to itself or to another Job Label. The output Job Label (**TOJOBLBL**) only supplies tape pool information. It does not allow the expiration date to be changed. All files or only active files can be duplicated. Once the duplication process completes, the original or duplicated volumes can be ejected.

Parameters

FROMVOL: Specifies the starting volume identifier to use. If the volume is part of a multi-volume set, MMS/*tms* will provide the additional volumes as determined by the sequence number range being duplicated.

***JOBLBL** The volumes duplicated are based on the Job Label specified in the FROMJOBLBL parameter.

Volume-identifier Enter the starting volume identifier.

FROMDEV: Specifies the device to use for the volume(s) being duplicated.

***FROMVOL** The device is determined by the volume.

Device-name Enter a valid device name.

FROMSEQNBR: Specifies the range of sequence numbers to duplicate.

Starting sequence: Specifies the beginning sequence number to duplicate.

***ALL** All sequence numbers are duplicated.

1-16777215 Enter a valid sequence number.

Ending sequence: Specifies the last sequence number to duplicate.

***ONLY** The value specified in the starting file sequence number is the only sequence being duplicated..

1-16777215 Enter a valid sequence number.

FROMJOBLBL: Specifies the Job Label containing the volumes being duplicated.

***DFT** The default Job Label is selected.

Job-label Enter a valid Job Label.

TODEV: Specifies the device to use for the output volume(s).

Device-name Enter a valid device name.

TOSEQNBR: Specifies the sequence number that the data files are to be copied to.

***FROMSEQ** The data files are copied to the same file sequences as are specified in the FROMSEQNBR parameter.

***END** The data files are added to the logical end of tape. The next valid sequence number is used.

1-16777215 Enter a valid sequence number.

TOJOBLBL: Specifies the Job Label and device to use for the output volumes.

***FROMVOL** The Job Label associated with the "From" volume is used.

Job-label Enter a valid Job Label.

EJECT: Specifies whether volumes are ejected.

***NONE** No volumes are ejected.

***COPY** The volumes duplicated to are ejected.

***SAVE** The volumes duplicated from are ejected.

DENSITY: Specifies the density of the device whose usage attributes to change.

***CTGTYPE** The media determined density is changed.

***DEVTYPE** The device determined density is changed.

Density Enter a density that is defined for the tape device being changed.

- COMPACT: Specifies whether device compaction is performed. If the specified device does not support device compaction, this parameter is ignored.
- *FROMFILE** Device compaction is performed only if the file being read from the device specified on the **FROMJOBBL** prompt was written using data compaction.
 - *YES Device data compaction is performed on all files written to the device specified on the **TOJOBBL** parameter.
 - *NO Device data compaction is not performed.
- FILES: Specifies if expired data files are copied from the tape volume placed in the device specified in the **FROMJOBBL** parameter to the tape volume specified in the **TOJOBBL** parameter.
- *ALL** All data files are copied. All existing file sequence numbers are saved.
 - *ACTIVE Only data files with an expiration date greater than the current system date are copied. Data files are renumbered consecutively, beginning with the number of the first file on the volume and omitting any files that have expired.

Examples

```
DUPVOL FROMVOL(350135) FROMDEV(TAPMLB01) TODEV(TAPMLB01) +
EJECT(*SAVE)
```

This duplicates all the volumes associated with volume 350135. The volumes are in tape library TAPMLB01 and when the duplication is complete, the original volumes are ejected.

```
DUPVOL FROMVOL(*JOBBL) FROMJOBBL(WEEKLY) TODEV(TAPMLB01) +
FILES(*ACTIVE)
```

This duplicates all the volumes associated with the last backup of Job Label WEEKLY. The volumes are copied to the scratch tapes in the tape pool associated with Job Label WEEKLY. Only the active data files are copied.

EJTVOL – Eject Volume

| Eject Volume (EJTVOL) | | Environment: B/I |
|--------------------------------|------------------|---------------------------|
| Library device | _____ | Name |
| Destination | <u>*DEV</u> | Name, *DEV, *CAS, *CNV... |
| Volume identifier | <u>*JOBLBL</u> | Char, *JOBLBL |
| + for more values | | |
| Job label | <u>*ALL</u> | Char, *DFT |
| + for more values | | |
| Location name | <u>*DFTLOC</u> | Name, *DFTLOC, *OFFSITE |
| Time period for volume output: | | |
| Starting date and time: | | |
| Beginning date | <u>*LASTSAVE</u> | Date, *LASTSAVE, *CURRENT |
| Beginning time | _____ | Time, *AVAIL |
| Ending date and time: | | |
| Ending date | _____ | Date, *CURRENT |
| Ending time | _____ | Time, *AVAIL |
| System name | <u>*LCL</u> | Name, *LCL |
| + for more values | _____ | |

Purpose

The Eject Volume (EJTVOL) command ejects up to 300 volumes or all volumes associated with up to 300 Job Labels from up to 10 systems connected to an IBM, Memorex/Telex or StorageTek tape library. The command prompts for the tape library exit facility prior to ejecting the volumes. The volumes can be ejected based on the last save of a Job Label, location or a specific date/time range. If multiple systems are used, they must be connected through the MMS/*tms* network.

Parameters

| | |
|-----------------------|--|
| DEV: | Specifies the name of the library device associated with the tape library. |
| <i>Library-device</i> | Enter the name of the library device. |
| DEST: | Specifies the destination to receive the tapes being ejected. If the destination is full, it must be unloaded before the remaining volumes can be ejected. |
| *DEV | The destination is specified on the tape Device Definition. Use the Work with Tape Device (WRKTAPDEV) command to view existing tape definitions. |
| *CAS | <u>For MTX Tape Libraries.</u> The tape is ejected into the MTX cartridge access station. |
| *CNV | <u>For IBM Tape Libraries.</u> The tape is ejected into the IBM convenience I/O station. |
| *HIGHCAP | <u>For IBM Tape Libraries.</u> The tape is ejected into the IBM high capacity output station. |
| <i>Destination</i> | Enter the name of the output destination. |

VOL: Specifies the volumes to eject. Up to 300 volumes can be entered. If special value ***JOBLBL** is specified, all volumes associated with the specified Job Label are ejected.

***JOBLBL** The volumes to be ejected are determined by the Job Label(s) specified in the **JOBLBL** parameter.

Volume-id Enter up to 300 volume identifiers.

JOBLBL: Specifies the Job Labels whose volumes to select. Up to 300 Job Labels can be specified.

***ALL** All Job Labels are selected.

***DFT** Volumes using the ***DFT** Job Label are selected.

Job-label Enter a valid Job Label.

LOC: Specifies the location of the volumes to select.

***DFTLOC** Volumes at the default location are selected.

***OFFSITE** Volumes at an off-site location are selected.

PERIOD: Specifies the period of time for which the volume data is shown. This parameter contains two lists of two elements each.

Beginning date: One of the following is used to specify the starting date on which or after which the data must have been logged. Any volumes saved before the specified date are not ejected.

***LASTSAVE** The save with the greatest save date/time is selected.

***CURRENT** The current day is the starting day for which logged data is selected.

Begin-date Enter the beginning date. The date must be specified in the job date format.

Beginning time: One of the following is used to specify the starting time at which or after which the data must have been logged. Any volumes saved before the specified time and date are not selected.

***AVAIL** The logged data that is available for the specified beginning date is used.

Begin-time Enter the beginning time for the specified beginning date that determines the logged data to be used. The time is specified in 24-hour format and can be specified with or without a time separator.

Ending date: One of the following is used to specify the ending date before which or on which the data must have been logged. Any volumes saved after the specified date are not selected.

***CURRENT** The last day on which data was logged is the last day for which the logged data is used.

End-date Enter the ending date for which logged data is used.

Ending time: One of the following is used to specify the ending time before which the data must have been logged. Any volumes saved after the specified time and date are not selected.

***AVAIL** The logged data that is available for the specified ending date is used.

End-time Enter the ending time for the specified ending date that determines the logged data to be used. The time is specified in 24-hour format and can be specified with or without a time separator.

SYSTEM: Specifies the system name of the volumes to be ejected. Up to 10 systems can be specified.

***LCL** Volumes from the local system are selected.

System-name Enter a valid system name.

Examples

```
EJTVOL DEV(TAPMLB01) DEST(*DEV) VOL(*JOBLBL) JOLBL(DAILY) +  
PERIOD(( *LASTSAVE )) SYSTEM(SYSTEMA SYSTEMB)
```

This ejects all volumes associated with the last save of Job Label DAILY on SYSTEMA and SYSTEMB in the MMS/*tms* network. The tape library name is TAPMLB01 and the device determines the destination for the ejected volumes.

```
EJTVOL DEV(RML9710) DEST(CAP9710) VOL(001001 001002 001003 001004)
```

This ejects the specified volumes from the tape library to a destination named CAP9710. The tape library that the volumes will be ejected from is a StorageTek tape library with a library device name of RML9710.

ENTVOL – Enter Volume

| | |
|---------------------------------------|------------------|
| Enter Volume (ENTVOL) | Environment: B/I |
| Cartridge access port _____ | Name |

Purpose

The Enter Volume (ENTVOL) command opens the user-specified Cartridge Access Port (CAP) and allows tapes to be entered into the tape library. This command should be used in place of the RMLS Enter Volume(s) into an RML (ENTRMLVOL) command. This command functions only with StorageTek tape libraries.

Parameters

CAP: Specifies the name of the Cartridge Access Port (CAP). The CAP must be in the RMLS/CSC configuration database and in the active run-time view.

Cartridge-access-port Enter the name of the Cartridge Access Port.

Examples

ENTVOL CAP(RML9710)

This allows CAP RML9710 to be opened. When all volumes have been entered into the CAP, close the door and MMS/*tms* verifies all volumes entering the StorageTek tape library.

INZTAP - Initialize Tape

| Initialize Tape (INZTAP) | | Environment: B/I |
|------------------------------|-----------------|---------------------------------|
| Tape device | _____ | Name |
| New volume identifier | <u>*NONE</u> | Character value, *NONE... |
| New owner identifier | <u>*BLANK</u> | |
| Volume identifier | <u>*MOUNTED</u> | Character value, *MOUNTED |
| Check for active files | <u>*YES</u> | *YES, *NO, *FIRST |
| Tape Density | <u>*CTGTYPE</u> | *CTGTYPE, *DEVTYPE, *QIC120 ... |
| Code | <u>*EBCDIC</u> | *EBCDIC, *ASCII |
| End of tape option | <u>*REWIND</u> | *REWIND, *UNLOAD |
| Clear | <u>*NO</u> | *NO, *YES |
| Number of volumes | <u>1</u> | 1-99 |
| Delay time for mount | <u>1</u> | 1-60 |

Purpose

The MMS/*tms* Initialize Tape (INZTAP) command is an enhanced version of the IBM iSeries command, which formats and optionally labels tapes with volume identifiers before they are used. The only parameters listed here are the parameters that are enhanced or added to the IBM command. Unless specified otherwise, all command parameters function like the IBM Initialize Tape command.

Parameters

NEWVOL: Specifies if the tape being initialized is a standard labeled or non-labeled tape. If no volume identifier is specified, the tape is initialized as a non-labeled tape.

***NONE** The volume is initialized as a non-labeled tape. *If the volume identifier on the tape exists in the database, it is deleted.*

***CTGID** The volume is initialized based on the bar code on the external tape cartridge label. This value is only valid for tapes in tape libraries.

***GEN** The volume is initialized based on the volume identifier specified in the tape usage attributes. Refer to the *Change Tape Usage (CHGTAPUSG)* command. *If the volume identifier on the tape exists in the database, it is reused in place of the one specified in the tape usage attributes.*

Volume-id Enter the volume identifier to use for the tape. The format of the volume identifier is determined by the tape usage attributes. Refer to the *Change Tape Usage (CHGTAPUSG)* command. *If the volume identifier on the tape exists in the database, it is reused in place of the one specified in the NEWVOL parameter.*

CHECK: Specifies if the volume should be checked for active data files before it is initialized for use.

***YES**

All data file labels on the tape are checked by OS/400 and the volume identifier is checked against the database.

If **no** active files are found on the tape and the volume is expired, the tape is initialized for use.

If active files **are** found on the tape and the volume is expired, the operation is ended and an error message is sent.

If active files **are** found on the tape and the volume was previously scratched, the tape is initialized for use.

If **no** active files are found on the tape and the volume is active, an inquiry message is sent to the requestor. The requestor has the option of continuing or canceling the initialize function.

If the volume is not in the database, this parameter is used as specified. If any active files are found, the operation is ended and an error message is sent.

***NO**

Tape initialization is based on the status of the volume in the database. If the volume is active, an inquiry message is sent to the requestor. The requestor has the option of continuing or canceling the initialize function. To initialize a new or empty volume for use, ***NO** must be specified.

***FIRST**

Only the **first** data file on the label is checked.

If **no** active files are found on the tape and the volume is expired, the tape is initialized for use.

If active files **are** found on the tape and the volume is expired, the operation is ended and an error message is sent.

If active files **are** found on the tape and the volume was previously scratched, the tape is initialized for use.

If **no** active files are found on the tape and the volume is active, an inquiry message is sent to the requestor. The requestor has the option of continuing or canceling the initialize function.

If the volume is not in the database, this parameter is used as specified. If any active files are found, the operation is ended and an error message is sent.

INZNBR: Specifies the number of tapes to be initialized during this process. This value is for tape libraries and tape stackers only.

1 Only one tape is initialized.

1 - 99 Enter the number of tapes to initialize.

DELAY: Specifies the delay time (in seconds) to wait before starting the initialize process. This value provides tape devices some time to perform the mount before the process starts. This value is for tape libraries and tape stackers only.

1 Delay the process by 1 second.

1 - 60 Enter the time (in seconds) to delay the initialize process.

Examples

INZTAP DEV(TAP01) NEWVOL(*GEN) ENDOPT(*UNLOAD)

Before the tape is initialized, the volume identifier is checked by MMS/*tms*. If the tape has a volume identifier and it exists in the MMS/*tms* database, the status of the volume is checked regardless of the value specified in the CHECK parameter. If the tape is active, an inquiry message is sent to the requestor. If the initialization continues, the volume identifier *previously* on the tape is used to reinitialize the tape. If the tape does not have a volume identifier or if the volume identifier does not exist in the MMS/*tms* database, the volume identifier specified in the tape usage attributes for device TAP01 will be used.

INZTAP DEV(TAP01) NEWVOL(*GEN) ENDOPT(*UNLOAD) INZNBR(10)

This initializes tapes in a tape stacker. Before the tape is initialized, the volume identifier is checked by MMS/*tms*. If the tape has a volume identifier and it exists in the MMS/*tms* database, the status of the volume is checked, regardless of the value specified in the CHECK parameter. If the tape is active, an inquiry message is sent to the requestor. If the initialize continues, the volume identifier *previously* on the tape is used to reinitialize the tape. If the tape does not have a volume identifier or if the volume identifier does not exist in the MMS/*tms* database, the volume identifier specified in the tape usage attributes for device TAP01 will be used.

INZTAP DEV(TAP08) NEWVOL(*CTGID) ENDOPT(*UNLOAD) INZNBR(40)

This initializes *new* tapes in a tape library. New tapes are tapes that have never been initialized before. The tapes are initialized based on the external tape bar code label. MMS/*tms* automatically initializes up to 40 new tapes, if available.

INZTAP DEV(TAP08) NEWVOL(*CTGID) VOL(001000) ENDOPT(*UNLOAD)

This mounts volume 001000 in a tape library. Before the tape is initialized, the volume identifier is checked by MMS/*tms*. If the tape has a volume identifier and it exists in the MMS/*tms* database, the status of the volume is checked, regardless of the value specified in the CHECK parameter. If the volume is active, an inquiry message is sent to the requestor. If the initialize continues, the tape is initialized to the value specified on its' bar code label.

```
INZTAP DEV(TAP01) NEWVOL(001000) ENDOPT(*UNLOAD)
```

Before the tape is initialized, the volume identifier is checked by MMS/*tms*. If the tape has a volume identifier and it exists in the MMS/*tms* database, the status of the volume is checked, regardless of the value specified in the CHECK parameter. If the volume is active, an inquiry message is sent to the requestor. If the initialize continues, the volume identifier *previously* on the tape is used to reinitialize the tape. If the tape does not have a volume identifier or if the volume identifier does not exist in the MMS/*tms* database, the volume identifier specified in this command will be used.

PRTRCYVOL - Print Recovery Volumes

| Print Recovery Volumes (PRTRCYVOL) | | Environment: B/I |
|------------------------------------|---------------|----------------------|
| Report sequence | <u> </u> | *JOBLBL, *LIB |
| Library | <u>*ALL</u> | Name, generic*, *ALL |
| + for more values | | |
| Job label | <u>*ALL</u> | Char, *ALL |
| + for more values | | |
| Number of saves per job label | <u>*ALL</u> | 1-99, *ALL |
| Print one Job label per page | <u>*YES</u> | *YES, *NO |
| System name | <u>*LCL</u> | Name, *LCL |

Purpose

The Print Recovery Volumes (PRTRCYVOL) command prints two types of recovery reports. The Recovery Report by Job Label prints the volumes used for one or more Job Labels. Up to 300 Job Labels can be specified. The information includes retention, location and volume information for all specified Job Labels. The number of prior saves per Job Label is controlled by the user; eliminating old volumes from the report. The report can be printed for the local system or for any other system in the MMS/*tms* network. The Recovery Report by Library prints the volumes used for each library. All volumes used for the save of the specified library are printed. The MMS Backup and Recovery module must be installed for this report.

Parameters

- TYPE:** Specifies the type of recovery report to print.
- *JOBLBL The Job Label Recovery Report is selected.
 - *LIB The Library Recovery Report is selected.
- LIBRARY:** Specifies the libraries whose volumes to select. Up to 300 libraries can be specified.
- *ALL All libraries are selected.
 - *ALLUSR All user libraries are selected.
 - *IBM All IBM libraries are selected.
 - *NONSYS All user and IBM libraries are selected.
 - Library-name* Enter a valid library name.
- JOBLBL:** Specifies the Job Labels whose volumes to select. Up to 300 Job Labels can be specified. This parameter is only valid for the Recovery Report by Job Label.
- *ALL All Job Labels are selected.
 - Job-label* Enter a valid Job Label.

NBRUSRSAV: Specifies the number of saves to print per Job Label. This parameter is only valid for the Recovery Report by Job Label.

***ALL** All saves associated with all Job Labels are printed.

1-99 Enter the number of saves to print per Job Label.

SYSTEM: Specifies the local (source) or remote (target) system to select. If a remote (target) system is specified, a communication link to the specified system is created. The remote (target) system definition must exist in MMS/*tms*. This parameter is only valid for the Recovery Report by Job Label.

***LCL** The local system is selected.

System-name Enter a valid system name.

RPTFMT: Specifies if one Job Label prints per page. This parameter is only valid for the Recovery Report by Job Label.

***YES** Each Job Label prints on its own page.

***NO** Multiple Job Labels print per page.

Examples

PRTRCYVOL TYPE(*JOBLBL) JOBLBL(*ALL) NBRUSRSAV(1)

This prints the last (most recent) save from all Job Labels.

PRTVOLLBL - Print Volume Label

| Print Volume Label (PRTVOLLBL) | | Environment: B/I |
|--------------------------------|-------------|-----------------------|
| Volume identifier | | Character value |
| Range | <u>*ALL</u> | *ALL, *ONLY |
| Media class | <u>*VOL</u> | *VOL, *REEL, *CART... |

| Purpose |
|--|
| The Print Volume Label (PRTVOLLBL) command prints a tape label to a user-specified output queue. The command has the ability to print only the volume entered, or it can print the entire range of volumes used, if the specified volume is part of a multi-volume save. The printer file attributes, such as output queue, can be changed. Refer to the <i>Work with Printer Files</i> (WRKPRTF) command for details. |

| Parameters |
|---|
| <p>VOL: Specifies the volume identifier(s) to be printed.</p> <p><i>Volume-id</i> Enter a volume identifier.</p> |
| <p>RANGE: Specifies if a tape label is printed for all volumes associated with the specified volume.</p> <p>*ALL All volumes associated with the specified volume are printed.</p> <p>*ONLY Only the volume specified is printed.</p> |
| <p>CLASS: Specifies the media class of the volume. The media class determines the type of label to print.</p> <p>*VOL The media class of the volume is used.</p> <p>*REEL The media class of the volume is reel.</p> <p>*CART The media class of the volume is cartridge.</p> <p>*QIC The media class of the volume is quarter inch.</p> <p>*8MM The media class of the volume is 8 millimeter.</p> |

| Examples |
|--|
| <p>PRTVOLLBL VOL(001000)</p> <p>This prints a tape label for volume 001000 and all associated volumes, if any.</p> |
| <p>PRTVOLLBL VOL(001000) RANGE(*ONLY)</p> <p>This prints a tape label for volume 001000 only. If volume 001000 is part of a multi-volume save, the associated volumes will not have a tape label printed.</p> |

PRTVOLSTS - Print Volume Status

Print Volume Status (PRTVOLSTS) Environment: B/I
Volume Status *ALL *ALL, *ACT, *ERR, *GEN, *SCR

Purpose

The Print Volume Status (PRTVOLSTS) command prints all volumes, which meet the selection criteria, for the last 24-hour period. The 24-hour period is based on the time that the command executes.

Parameters

STATUS: Specifies the status of the volumes.

| | |
|-------------|--|
| <u>*ALL</u> | All volumes, regardless of status, are printed. |
| *ACT | Active volumes are printed. |
| *ERR | Error volumes are printed. Error volumes are created when a save ends abnormally and the data is incomplete. |
| *GEN | Generation volumes are printed. Generation volumes are active volumes using retention by generation. |
| *SCR | Scratch volumes are printed. Scratch volumes are available for use. |

Examples

PRTVOLSTS VOL (*ALL)
This prints all volumes used within the last 24-hour period.

PRTVOLSTS VOL (*ERR)
This prints all volumes that did complete normally within the last 24-hour period.

RTVJOBLBL - Retrieve Job Label

| Retrieve Job Label (RTVJOBLBL) | | Environment: I/B |
|----------------------------------|-----------------|------------------|
| Job label | _____ | |
| Retrieve by generations. | <u>*NO</u> | *NO, *YES |
| Generations number. | <u>*CURRENT</u> | 1-9999, *CURRENT |
| Volume number | <u>*FIRST</u> | *FIRST, *LAST |
| CL var for VOLUME (1) | _____ | Character value |

Purpose

The Retrieve Job Label (RTVJOBLBL) command provides a programming interface that allows the first or last volume associated with (1) the last save or (2) a specific generation to be retrieved. This command can only be used in an interactive or batch program. When used, the command returns the first or last volume to the program. This command can be used for user-created recovery programs.

Parameters

- JOBLBL:** Specifies the name of the Job Label whose volume is retrieved.
Job-label Enter a valid Job Label.
- RTVGEN:** Specifies if generations are used to select the volume(s).
*NO The volume(s) are not selected by generation.
 *YES The volume(s) are selected by generation.
- GENNBR:** Specifies the generation number to retrieve. If a number specified is higher than the actual number of generations available, the volume from the last available generation is returned. This value is only used if ***YES** is specified for the **RTVGEN** parameter.
*CURRENT Specifies that the last backup generation is returned.
 1-9999 Enter a number from 1 to 9999 indicating the generation number to retrieve.
- VOLNBR:** Specifies which volume from a multi-volume save to return. If the save is not a multi-volumes save, the same volume identifier is returned regardless of the value specified for this parameter.
*FIRST The first volume is returned.
 *LAST The last volume is returned.
- VOL:** Specifies the name of the CL variable that receives the volume identifier. The variable must be a character variable with a minimum length of 6-characters.
Variable Enter the name of the variable that will contain the returned volume identifier.

Examples

```
RTVJOBLBL  JOBLBL(DAILY) RTVGEN(*NO) VOLNBR(*FIRST) VOL(&VOLUME)
```

This retrieves the first volume from the last save that used Job Label DAILY and places it into a CL variable named &VOLUME. The variable must exist in the program using this command.

```
RTVJOBLBL  JOBLBL(DAILY) RTVGEN(*YES) GENNBR(1) +  
          VOLNBR(*LAST) VOL(&VOLUME)
```

This retrieves the last volume from the most current generation save that used Job Label DAILY and places it into a CL variable named &VOLUME. The variable must exist in the program using this command.

RTVVOL - Retrieve Volume

| Retrieve Volume (RTVVOL) | | Environment: B/I |
|--------------------------|-----------------|----------------------------------|
| Device | | Name |
| Volume identifier | <u>*MOUNTED</u> | Character value, *MOUNTED |
| Job label | <u>*DFT</u> | Character value, *DFT, *NONE |
| Text 'description' | <u>*JOBLBL</u> | Character value, *BLANK, *JOBLBL |
| End of tape option | <u>*REWIND</u> | *REWIND, *LEAVE, *UNLOAD |
| Retrieval level | <u>*JOBLBL</u> | *JOBLBL, *LABELS, *SAVRST |

Purpose

The Retrieve Volume (RTVVOL) command retrieves tapes into the MMS/*tms* database. This command requires that the tape is mounted and the tape device is in ready status. Options allow you to retrieve the volume and contents at library level (fastest processing) or object level (slower processing). The volume can be associated with a Job Label and have its' expiration date based on the Job Label. Documents, folders and integrated file system objects are not supported.

Parameters

- DEV:** Specifies the tape device to use.
Device-name Enter a valid device name.
- VOL:** Specifies the volume identifier of the volume being retrieved. A volume identifier is required for tape libraries.
*MOUNTED The volume mounted on the specified device is retrieved.
Volume-id Enter the volume identifier. The volume identifier is required for tape libraries.
- JOBLBL:** Specifies the Job Label to be associated with the retrieved volume.
*DFT The default Job Label is associated with the volume.
 *NONE No Job Label is associated with the volume.
Job-label Enter a valid Job Label.
- TEXT:** Specifies the text that briefly describes the object.
*JOBLBL The text on the specified Job Label is associated with the volume.
 *BLANK No text is associated with the volume.
'description' Enter no more than 50 characters of text, enclosed in apostrophes.

ENDOPT: Specifies whether the tape is rewound only or rewound and unloaded after the operation ends.

| | |
|----------------|--|
| *REWIND | The tape is rewound, but not unloaded. |
| *LEAVE | The tape is not rewound. |
| *UNLOAD | The tape is automatically rewound and unloaded after the operation ends. |

RTVLVL: Specifies the amount of information to retrieve from the volume. This value is used for all sequences on the volume. Member level information is not provided.

| | |
|----------------|--|
| *JOBLBL | The amount of information retrieved is based on the specified Job Label. |
| *LABELS | The data set name is retrieved. |
| *SAVRST | Save/restore information is retrieved. This includes library and object information. |

Examples

RTVVOL DEV(TAP01) ENDOPT(*UNLOAD)

This retrieves the volume mounted on TAP01. The volume is retrieved at library level (default). When complete, the tape is rewound and unloaded from the tape device.

RTVVOL DEV(TAP01) JOBLBL(DAILY) TEXT(*JOBLBL) ENDOPT(*UNLOAD)

This retrieves the volume mounted on TAP01. The volume is associated with Job Label DAILY and the volume text is based on the Job Label. The volume is retrieved at library level (default), and when complete, the tape is rewound and unloaded from the tape device.

RTVVOL DEV(TAP08) VOL(001000) ENDOPT(*UNLOAD) RTVLVL(*JOBLBL)

This mounts tape 001000 in a tape library and retrieves it at the value specified for Job Label *DFI. When complete, the tape is rewound and unloaded from the tape device.

SCNLOG - Scan History Log

| Scan History Log (SCNLOG) | | Environment: I |
|------------------------------|-----------------|------------------------|
| Find 'string' | _____ | |
| Time period for scan output: | | |
| Starting date and time: | | |
| Beginning date | <u>*CURRENT</u> | Date, *CURRENT, *BEGIN |
| Beginning time | <u>*AVAIL</u> | Time, *AVAIL |
| Ending date and time: | | |
| Ending date | <u>*CURRENT</u> | Date, *CURRENT, *END |
| Ending time | <u>*AVAIL</u> | Time, *AVAIL |
| Output | <u>*</u> | *, *PRINT |

Purpose

The Scan History Log (SCNLOG) command scans the iSeries history log for a specific user-defined character string. The scan bases the search on user-specified date/time selection criteria. The information can be printed or selected on a display device.

Parameters

STRING: Specifies the character or hexadecimal string to search for, enclosed in single quotation marks.

'String' Enter the character/hexadecimal string.

PERIOD: Specifies the period of time for which the logged data is selected. This parameter contains two lists of two elements each.

Beginning date: One of the following is used to specify the starting date on which or after which the data must have been logged. Any data logged before the specified date is not selected.

***CURRENT** The logged data for the current day and between the specified starting and ending times (if specified) is selected.

***BEGIN** The logged data from the earliest available date is selected.

Begin-date Enter the beginning date. The date must be specified in the job date format.

Beginning time: One of the following is used to specify the starting time at which or after which the data must have been logged. Any data logged before the specified time and date are not selected.

***AVAIL** The logged data that is available for the specified beginning date is selected.

Begin-time Enter the beginning time for the specified beginning date that determines the logged data to be selected. The time is specified in 24-hour format and can be specified with or without a time separator.

Ending date: One of the following is used to specify the ending date before which or on which the data must have been logged. Any data logged after the specified date is not selected.

***CURRENT** The last day on which data was logged is the last day for which the logged data is selected.

End-date Enter the ending date for which logged data is selected. The date must be specified in the job date format.

Ending time: One of the following is used to specify the ending time before which the data must have been logged. Any data logged after the specified time and date is not selected.

***AVAIL** The logged data that is available for the specified ending date is selected.

End-time Enter the ending time for the specified ending date that determines the logged data to be selected. The time is specified in 24-hour format and can be specified with or without a time separator.

OUTPUT: Specifies whether the output from the command is displayed at the requesting workstation or printed with the job's spooled output.

***** The output is displayed (if requested by an interactive job) or printed with the job's spooled output (if requested by a batch job).

***PRINT** The output is printed with the job's spooled output.

Examples

```
SCNLOG STRING('saved') PERIOD((080104 200000) (080204 080000))
```

This scans the IBM history log for the value "saved" for the period of 08/01/04 at 20:00:00 to 08/02/04 at 08:00:00. All entries containing the character string "saved" are displayed.

```
SCNLOG STRING('saved') PERIOD((080104 200000) (080204 080000)) +  
OUTPUT(*PRINT)
```

This scans the IBM history log for the value "saved" for the period of 08/01/04 at 20:00:00 to 08/02/04 at 08:00:00. All entries containing the character string "saved" are printed.

STRCMNLNK - Start Communication Link

| | | |
|-----------------------|--------------------------------------|------------------|
| | Start Communication Link (STRCMNLNK) | Environment: B/I |
| Remote location | _____ | Name |
| Start remote | <u>*YES</u> | *YES, *NO |

| | |
|---------|---|
| Purpose | The Start Communication Link (STRCMNLNK) command starts a communication link that was previously ended with the End Communication Link (ENDCMNLNK) command, or a newly created link, without having to end and restart the QLXI subsystem. The remote (target) location definition must exist in MMS/ <i>tms</i> . The QLXI subsystem must be active in order for a communication link to start. Options provide the ability to start communications from the remote location to the local location. |
|---------|---|

| | | | | | | | |
|------------------------|--|------------------------|--------------------------------|-------------|--|-----|--|
| Parameters | <p>RMTLOCNAME: Specifies the remote (target) location to start.</p> <table> <tr> <td style="text-align: right;"><i>Remote-location</i></td> <td>Enter a valid remote location.</td> </tr> </table> <p>STRRMT: Specifies if communication from the specified remote location to this location should be started.</p> <table> <tr> <td style="text-align: right;">*YES</td> <td>The communication link from the remote location to this location is started.</td> </tr> <tr> <td style="text-align: right;">*NO</td> <td>The communication link from the remote location to this location is not started.</td> </tr> </table> | <i>Remote-location</i> | Enter a valid remote location. | *YES | The communication link from the remote location to this location is started. | *NO | The communication link from the remote location to this location is not started. |
| <i>Remote-location</i> | Enter a valid remote location. | | | | | | |
| *YES | The communication link from the remote location to this location is started. | | | | | | |
| *NO | The communication link from the remote location to this location is not started. | | | | | | |

| | |
|----------|---|
| Examples | <p>STRCMNLNK RMTLOCNAME (SYSTEMB) This starts the communication link to the remote (target) location SYSTEMB. Subsystem QLXI must be active.</p> <p>STRCMNLNK RMTLOCNAME (SYSTEMB) STRRMT (*YES) This starts the communication link job from this system to the remote (target) location SYSTEMB and the communication link from SYSTEMB to this location. The communication link jobs run in subsystem QLXI.</p> |
|----------|---|

TSTCMNLNK - Test Communication Link

Test Communication Link (TSTCMNLNK) Environment: B/I

Remote location _____ Name

Purpose

The Test Communication Link (TSTCMNLNK) command tests a communication link between the local (source) and remote (target) systems. The remote (target) location definition must exist in MMS/*tm*. The test verifies that the communication link is active and that the remote (target) transaction program is functioning. If the test is successful, a completion message is sent to the requestor. If the test fails, an escape message is sent to the requestor.

Parameters

RMTLOCNAME: Specifies the remote (target) location to test.

Remote-location Enter a valid remote location.

Examples

TSTCMNLNK RMTLOCNAME (SYSTEMB)

This tests the communication link to remote (target) location SYSTEMB.

UPDTAPLIB - Update Tape Library

| Update Tape Library (UPDTAPLIB) | | Environment: B/I |
|---------------------------------|--------------|-------------------|
| Library device | _____ | Name |
| Remote library device . . | <u>*NONE</u> | Name, *NONE, *ALL |
| System | _____ | Name |
| + for more values | _____ | |

| | |
|---------|---|
| Purpose | The Update Tape Library (UPDTAPLIB) command updates the MMS/ <i>tms</i> database with the tape volume information from the specified tape library. Options include the ability to update other MMS/ <i>tms</i> tape library databases within the MMS/ <i>tms</i> network. |
|---------|---|

| | |
|------------|---|
| Parameters | <p>DEV: Specifies the name of the library device (tape library robot). <i>Library-device</i> Enter the name of the library device.</p> <p>RMTDEV: Specifies the name of the remote library device (tape library robot) and system to update with the local tape library information.</p> <p><u>Remote library device:</u> Specifies the name of the remote tape library databases to update.</p> <p style="padding-left: 40px;">*NONE No remote tape library databases are updated.</p> <p style="padding-left: 40px;">*ALL All remote tape library databases are updated. This value updates all remote tape library databases on all systems defined within the MMS/<i>tms</i> network.</p> <p style="padding-left: 40px;"><i>Library-device</i> Enter the name of the remote device. This value is ignored when *ALL is specified for the Remote Library Device parameter.</p> <p><u>System:</u> Specifies the system that contains the tape library database being updated. The system must be defined to MMS/<i>tms</i>.</p> <p style="padding-left: 40px;"><i>System-name</i> Enter the name of the remote system.</p> |
|------------|---|

| | |
|----------|---|
| Examples | <p>UPDTAPLIB DEV(RML01) RMTDEV(*ALL)</p> <p>This updates the tape library database associated with library device RML01 on all system defined within the MMS/<i>tms</i> network.</p> |
|----------|---|

WRKCMNLNK - Work with Communication Link

Work with Communication Link (WRKCMNLNK) Environment: I

| | | |
|-----------------------|---------------|--------------|
| Remote location | <u>*ALL</u> | Name, *ALL |
| Wait time | <u>*NOMAX</u> | 1-99, *NOMAX |
| Output | <u>*</u> | *, *PRINT |

Purpose

The Work with Communication Link (WRKCMNLNK) lists all or specific remote communication links and the pending transactions associated with the link.

Parameters

RMTLOCNAME: Specifies the name of the remote (target) location to select.

| | |
|------------------------|---------------------------------------|
| <u>*ALL</u> | All communication links are selected. |
| <i>Remote-location</i> | Enter a valid remote location. |

WAIT: Specifies the amount of time (in seconds) that must elapse before the display is automatically refreshed.

| | |
|------------------|--------------------------------------|
| <u>*NOMAX</u> | The display does not refresh itself. |
| <i>Wait-time</i> | Enter a value from 1 to 99. |

OUTPUT: Specifies whether the output from the command is displayed at the requesting workstation or printed with the job's spooled output.

| | |
|----------|--|
| <u>*</u> | The output is displayed (if requested by an interactive job) or printed with the job's spooled output (if requested by a batch job). |
| *PRINT | The output is printed with the job's spooled output. |

Examples

WRKCMNLNK RMTLOCNAME(*ALL)

This displays the Work with Communication Link panel. The list contains an entry for all remote locations defined to MMS/tms.

WRKJOBLBL - Work with Job Label

| Work with Job Label (WRKJOBLBL) | | Environment: I |
|---------------------------------|-------------|------------------|
| Job label | <u>*ALL</u> | Name, *ALL, *DFT |
| System name | <u>*LCL</u> | Name, *LCL |
| Output | <u>*</u> | *, *PRINT |

Purpose

The Work with Job Label (WRKJOBLBL) lists all or specific Job Labels.

Parameters

- JOBLBL:** Specifies the Job Label to select.
- *ALL** All Job Labels are selected.
 - *DFT** The default Job Label is selected.
 - Job-label* Enter a valid Job Label.
- SYSTEM:** Specifies the local (source) or remote (target) system to select. If a remote (target) system is specified, a communication link to the specified system is created. The remote (target) system definition must exist in MMS/*tms*.
- *LCL** The local system is selected.
 - System-name* Enter a valid system name.
- OUTPUT:** Specifies whether the output from the command is displayed at the requesting workstation or printed with the job's spooled output.
- *** The output is displayed (if requested by an interactive job) or printed with the job's spooled output (if requested by a batch job).
 - *PRINT** The output is printed with the job's spooled output.

Examples

WRKJOBLBL JOBLBL (*ALL)
 This displays the Work with Job Label panel. The list contains an entry for all Job Labels.

WRKPRTF - Work with Printer Files

Work with Printer Files (WRKPRTF) Environment: I
Product identifier _____ *AMS, *BMS, *CMS, *SPL, *TMS

Purpose

The Work with Printer Files (WRKPRTF) command lists all printer files associated with a specific LXI product.

Parameters

PRDID: Specifies the LXI product printer files to select.

| | |
|------|--------------------------|
| *AMS | Archive Management. |
| *BMS | Backup Management. |
| *CMS | Vault Management. |
| *SPL | Spooled File Management. |
| *TMS | MMS Tape Management. |

Examples

WRKPRTF PRDID (*TMS)
This displays the Work with Printer Files panel. The list contains an entry for all printer files in the MMS/*tms* product.

WRKRTVLVL - Work with Retrieval Level

Work with Retrieval Level (WRKRTVLVL) Environment: B/I

Library *ALL Name, generic*, *ALL

Purpose

The Work with Retrieval Level (WRKRTVLVL) command displays the retrieval level of all or specific libraries and save files.

Parameters

LIBRARY: Specifies the name of the library to select.
*ALL All libraries are selected.
Library-name Enter a valid library name.

Examples

WRKRTVLVL LIBRARY(ACCTLIB)
 This displays the retrieval level entry for library ACCTLIB.

WRKSAVDLO - Work with Saved DLO

| Work with Saved DLO (WRKSAVDLO) | | Environment: I |
|---------------------------------|-----------------|------------------------|
| Path name | / _____ | Name, *NONE, / |
| Time period for volume output: | | |
| Starting date and time: | | |
| Beginning date | <u>*BEGIN</u> | Date, *CURRENT, *BEGIN |
| Beginning time | <u>*AVAIL</u> | Time, *AVAIL |
| Ending date and time: | | |
| Ending date | <u>*CURRENT</u> | Date, *CURRENT |
| Ending time | <u>*AVAIL</u> | Time, *AVAIL |
| Job label | <u>*ALL</u> | Name, *ALL |
| System name | <u>*LCL</u> | Name, *LCL |
| Output | <u>*</u> | *, *PRINT, *OUTFILE |
| File to receive output | | |
| Library | <u>*LIBL</u> | Name, *LIBL |
| Output member options: | | |
| Member to receive output . . . | <u>*FIRST</u> | Name, *FIRST |
| Replace or add records | <u>*REPLACE</u> | *REPLACE, *ADD |

Purpose

The Work with Saved Document Library Objects (WRKSAVDLO) command lists saved document library objects (DLO) based on user-defined selection criteria. The information includes the document library object type, description, create date, path, save date/time, volume and sequence. The information can be printed or displayed on a display device. Additional information, including volume information can be displayed.

Parameters

PATH: Specifies the path name of the document library object.

 / All objects from the home directory are selected.

 *NONE Documents that do not reside in a folder are selected.

Path-name Enter a valid path name.

- PERIOD:** Specifies the period of time for which the saved DLO data is selected. This parameter contains two lists of two elements each.
- Beginning date:** One of the following is used to specify the starting date on which or after which the data must have been logged. Any DLO saved before the specified date are not selected.
- *BEGIN** The logged data from the beginning of the MMS/*tms* database is selected.
 - *CURRENT** The logged data for the current day and between the specified starting and ending times (if specified) is selected.
 - Begin-date* Enter the beginning date. The date must be specified in the job date format.
- Beginning time:** One of the following is used to specify the starting time at which or after which the data must have been logged. Any DLO saved before the specified time and date are not selected.
- *AVAIL** The logged data that is available for the specified beginning date is selected.
 - Begin-time* Enter the beginning time for the specified beginning date that determines the logged data to be selected. The time is specified in 24-hour format and can be specified with or without a time separator.
- Ending date:** One of the following is used to specify the ending date before which or on which the data must have been logged. Any DLO saved after the specified date are not selected.
- *CURRENT** The last day on which data was logged is the last day for which the logged data is selected.
 - End-date* Enter the ending date for which logged data is selected. The date must be specified in the job date format.
- Ending time:** One of the following is used to specify the ending time before which the data must have been logged. Any DLO saved after the specified time and date are not selected.
- *AVAIL** The logged data that is available for the specified ending date is selected.
 - End-time* Enter the ending time for the specified ending date that determines the logged data to be selected. The time is specified in 24-hour format and can be specified with or without a time separator.

| | |
|----------|--|
| JOBLBL: | Specifies the Job Label of the document library objects to select. |
| | *ALL All Job Labels are selected. |
| | <i>Job-label</i> Enter a valid Job Label. |
| SYSTEM: | Specifies the local (source) or remote (target) system to select. If a remote (target) system is specified, a communication link to the specified system is created. The remote (target) system definition must exist in MMS/ <i>tms</i> . |
| | *LCL The local system is selected. |
| | <i>System-name</i> Enter a valid system name. |
| OUTPUT: | Specifies whether the output from the command is displayed at the requesting workstation or printed with the job's spooled output. |
| | * The output is displayed (if requested by an interactive job) or printed with the job's spooled output (if requested by a batch job). |
| | *PRINT The output is printed with the job's spooled output. |
| | *OUTFILE The output is directed to the database output file specified on the "File to receive output" prompt (OUTFILE parameter). |
| OUTFILE: | Specifies the name and library of the database output file to which the output of the command is directed. If the file does not exist, this command creates a database output file in the specified library. |
| | <u>File to receive output:</u> |
| | <i>File-name</i> Enter the name of the database file where the output is directed. |
| | <u>Library:</u> |
| | *LIBL Searches all libraries in the job's library list until the first match is found for the value in the OUTFILE field. If the file does not exist, it is created in the QGPL library. |
| | <i>Library-name</i> Enter a valid library name. |

OUTMBR: Specifies the name of the database file member that receives the output of the command.

Members to receive output:

***FIRST** The first member in the file receives the output. If no members exist in the file, the system creates a member with the name of the file specified in the "File to receive output": prompt (**OUTFILE** parameter).

Member-name Enter the name of the file member that receives the output. If the name does not exist, the system creates it.

Replace or add records:

***REPLACE** The output data replaces any existing records in the specified file member.

***ADD** The output data is added to the end of existing records in the specified file member.

Examples

WRKSAVDLO PATH(VAC*) PERIOD((080104))

This displays the Work with Saved DLO panel. The list contains an entry for all DLO that starts with VAC and was saved from 08/01/04 to the current date.

WRKSAVLNK – Work with Saved Link

| Work with Saved Link (WRKSAVLNK) | | Environment: B/I |
|----------------------------------|-----------------|------------------------|
| Object name | / _____ | Name |
| Time period for volume output: | | |
| Starting date and time: | | |
| Beginning date | <u>*BEGIN</u> | Date, *CURRENT, *BEGIN |
| Beginning time | <u>*AVAIL</u> | Time, *AVAIL |
| Ending date and time: | | |
| Ending date | <u>*CURRENT</u> | Date, *CURRENT |
| Ending time | <u>*AVAIL</u> | Time, *AVAIL |
| Job label | <u>*ALL</u> | Name, *ALL |
| System name | <u>*LCL</u> | Name, *LCL |
| Output | * | *, *PRINT, *OUTFILE |
| File to receive output | | |
| Library | <u>*LIBL</u> | Name, *LIBL |
| Output member options: | | |
| Member to receive output | <u>*FIRST</u> | Name, *FIRST |
| Replace or add records | <u>*REPLACE</u> | *REPLACE, *ADD |

Purpose

The Work with Saved Link (WRKSAVLNK) command shows saved links based on user-defined selection criteria. The information includes the object link, save date/time, Job Label, volume and sequence. The information can be printed or shown on a display device. Additional information, including volume information can be displayed.

Parameters

- OBJ: Specifies the path name of the saved link.
- / All objects from the home directory are selected.
- Object-name* Enter a valid object name.

- PERIOD:** Specifies the period of time for which the saved link data is selected. This parameter contains two lists of two elements each.
- Beginning date:** One of the following is used to specify the starting date on which or after which the data must have been logged. Any objects saved before the specified date are not selected.
- *BEGIN** The logged data from the beginning of the MMS/*tms* database is selected.
 - *CURRENT** The logged data for the current day and between the specified starting and ending times (if specified) is selected.
- Begin-date* Enter the beginning date. The date must be specified in the job date format.
- Beginning time:** One of the following is used to specify the starting time at which or after which the data must have been logged. Any objects saved before the specified time and date are not selected.
- *AVAIL** The logged data that is available for the specified beginning date is selected.
- Begin-time* Enter the beginning time for the specified beginning date that determines the logged data to be selected. The time is specified in 24-hour format and can be specified with or without a time separator.
- Ending date:** One of the following is used to specify the ending date before which or on which the data must have been logged. Any objects saved after the specified date are not selected.
- *CURRENT** The last day on which data was logged is the last day for which the logged data is selected.
- End-date* Enter the ending date for which logged data is selected. The date must be specified in the job date format.
- Ending time:** One of the following is used to specify the ending time before which the data must have been logged. Any objects saved after the specified time and date are not selected.
- *AVAIL** The logged data that is available for the specified ending date is selected.
- End-time* Enter the ending time for the specified ending date that determines the logged data to be selected. The time is specified in 24-hour format and can be specified with or without a time separator.

| | |
|----------|--|
| JOBLBL: | Specifies the Job Label used to save the link. |
| | *ALL All Job Labels are selected. |
| | <i>Job-label</i> Enter a valid Job Label. |
| SYSTEM: | Specifies the local (source) or remote (target) system to select. If a remote (target) system is specified, a communication link to the specified system is created. The remote (target) system definition must exist in MMS/ <i>tms</i> . |
| | *LCL The local system is selected. |
| | <i>System-name</i> Enter a valid system name. |
| OUTPUT: | Specifies whether the output from the command is displayed at the requesting workstation or printed with the job's spooled output. |
| | * The output is displayed (if requested by an interactive job) or printed with the job's spooled output (if requested by a batch job). |
| | *PRINT The output is printed with the job's spooled output. |
| | *OUTFILE The output is directed to the database output file specified on the "File to receive output" prompt (OUTFILE parameter). |
| OUTFILE: | Specifies the name and library of the database output file to which the output of the command is directed. If the file does not exist, this command creates a database output file in the specified library. |
| | <u>File to receive output:</u> |
| | <i>File-name</i> Enter the name of the database file where the output is directed. |
| | <u>Library:</u> |
| | *LIBL Searches all libraries in the job's library list until the first match is found for the value in the OUTFILE field. If the file does not exist, it is created in the QGPL library. |
| | <i>Library-name</i> Enter a valid library name. |

OUTMBR: Specifies the name of the database file member that receives the output of the command.

Members to receive output:

***FIRST**

The first member in the file receives the output. If no members exist in the file, the system creates a member with the name of the file specified in the “File to receive output” prompt (**OUTFILE** parameter).

Member-name

Enter the name of the file member that receives the output. If the name does not exist, the system creates it.

Replace or add records:

***REPLACE**

The output data replaces any existing records in the specified file member.

***ADD**

The output data is added to the end of existing records in the specified file member.

Examples

WRKSAVLNK

This displays all saved links.

WRKSAVLNK OBJ(dev) PERIOD((080104)) OUTPUT(*PRINT)

This prints the link named “dev” and was saved from 08/01/04 to the current date.

WRKSAVOBJ - Work with Saved Object

| Work with Saved Object (WRKSAVOBJ) | | Environment: I |
|------------------------------------|-----------------|------------------------|
| Object name | <u>*ALL</u> | Name, *ALL |
| Library | <u>*ALL</u> | Name, *ALL |
| Object type | <u>*ALL</u> | Name, *ALL |
| Time period for volume output: | | |
| Starting date and time: | | |
| Beginning date | <u>*BEGIN</u> | Date, *CURRENT, *BEGIN |
| Beginning time | <u>*AVAIL</u> | Time, *AVAIL |
| Ending date and time: | | |
| Ending date | <u>*CURRENT</u> | Date, *CURRENT |
| Ending time | <u>*AVAIL</u> | Time, *AVAIL |
| Job label | <u>*ALL</u> | Name, *ALL |
| System name | <u>*LCL</u> | Name, *LCL |
| Output | <u>*</u> | *, *PRINT, *OUTFILE |
| File to receive output | <u>*</u> | |
| Library | <u>*LIBL</u> | Name, *LIBL |
| Output member options: | | |
| Member to receive output . . . | <u>*FIRST</u> | Name, *FIRST |
| Replace or add records | <u>*REPLACE</u> | *REPLACE, *ADD |

Purpose

The Work with Saved Object (WRKSAVOBJ) command lists saved objects based on user-defined selection criteria. The information includes the library, object type, attribute, save command, save date/time, volume and sequence. The information can be printed or shown on a display device. Additional information, including volume information can be displayed. Only the base volume is shown if the object being displayed/printed spans multiple volumes. To view all tapes associated with the save, use **Option 5** to Work with the volumes.

Parameters

OBJ: Specifies the name of the saved object.

Object:

*ALL All saved objects meeting the selection criteria are selected.

generic* Enter the generic name of the objects to be selected. A generic name is a character string that contains one or more characters followed by an asterisk (*).

Object-name Enter a valid object name.

Library:

*ALL All saved libraries in MMS/*tms* are searched.

Library-name Enter a valid library name.

OBJTYPE: Specifies which type of objects are selected.

***ALL** All object types are selected.

Object-type Enter the object type for the objects to be selected, such as command ***CMD**, ***FILE**, or ***PGM**.

PERIOD: Specifies the period of time for which the saved object data is selected. This parameter contains two lists of two elements each.

Beginning date: One of the following is used to specify the starting date on which or after which the data must have been logged. Any objects saved before the specified date are not selected.

***BEGIN** The logged data from the beginning of the MMS/*tms* database is selected.

***CURRENT** The logged data for the current day and between the specified starting and ending times (if specified) is selected.

Begin-date Enter the beginning date. The date must be specified in the job date format.

Beginning time: One of the following is used to specify the starting time at which or after which the data must have been logged. Any objects saved before the specified time and date are not selected.

***AVAIL** The logged data that is available for the specified beginning date is selected.

Begin-time Enter the beginning time for the specified beginning date that determines the logged data to be selected. The time is specified in 24-hour format and can be specified with or without a time separator.

Ending date: One of the following is used to specify the ending date before which or on which the data must have been logged. Any objects saved after the specified date are not selected.

***CURRENT** The last day on which data was logged is the last day for which the logged data is selected.

End-date Enter the ending date for which logged data is selected. The date must be specified in the job date format.

| | |
|----------------------|--|
| <u>Ending time:</u> | One of the following is used to specify the ending time before which the data must have been logged. Any object saved after the specified time and date are not selected. |
| <u>*AVAIL</u> | The logged data that is available for the specified ending date is selected |
| <i>End-time</i> | Enter the ending time for the specified ending date that determines the logged data to be selected. The time is specified in 24-hour format and can be specified with or without a time separator. |
| JOBLBL: | Specifies the Job Label used to save the object. |
| <u>*ALL</u> | All Job Labels are selected. |
| <i>Job-label</i> | Enter a valid Job Label. |
| SYSTEM: | Specifies the local (source) or remote (target) system to select. If a remote (target) system is specified, a communication link to the specified system is created. The remote (target) system definition must exist in MMS/ <i>tms</i> . |
| <u>*LCL</u> | The local system is selected. |
| <i>System-name</i> | Enter a valid system name. |
| OUTPUT: | Specifies whether the output from the command is displayed at the requesting workstation or printed with the job's spooled output. |
| <u>*</u> | The output is displayed (if requested by an interactive job) or printed with the job's spooled output (if requested by a batch job). |
| *PRINT | The output is printed with the job's spooled output. |
| *OUTFILE | The output is directed to the database output file specified on the "File to receive output" prompt (OUTFILE parameter). |

OUTFILE: Specifies the name and library of the database output file to which the output of the command is directed. If the file does not exist, this command creates a database output file in the specified library.

File to receive output:

File-name Enter the name of the database file where the output is directed.

Library:

***LIBL** Searches all libraries in the job's library list until the first match is found for the value in the **OUTFILE** field. If the file does not exist, it is created in the **QGPL** library.

Library-name Enter a valid library name.

OUTMBR: Specifies the name of the database file member that receives the output of the command.

Members to receive output:

***FIRST** The first member in the file receives the output. If no members exist in the file, the system creates a member with the name of the file specified in the "File to receive output" prompt (**OUTFILE** parameter).

Member-name Enter the name of the file member that receives the output. If the name does not exist, the system creates it.

Replace or add records:

***REPLACE** The output data replaces any existing records in the specified file member.

***ADD** The output data is added to the end of existing records in the specified file member.

Examples

```
WRKSAVOBJ OBJ(ACCTLIB/ACC*) OBJTYPE(*FILE) +
PERIOD((080104) (090104)) JOBLBL(ACCT_BKUP)
```

This displays the Work with Saved Object panel. The list contains an entry for all objects, saved from ACCTLIB, that starts with ACC, is a *FILE and was saved between 08/01/04 and 09/01/04 using a Job Label named ACCT_BKUP.

WRKTAPDEV - Work with Tape Device

Work with Tape Device (WRKTAPDEV) Environment: I

| | | |
|-------------------|-------------|------------|
| Device name | <u>*ALL</u> | Name, *ALL |
| Output | <u>*</u> | *, *PRINT |

| | |
|---------|---|
| Purpose | The Work with Tape Device (WRKTAPDEV) command lists all or specific tape devices defined to MMS/ <i>tms</i> . |
|---------|---|

| | |
|------------|--|
| Parameters | <p>DEV: Specifies the tape devices to select.</p> <p> <u>*ALL</u> All tape devices defined to MMS/<i>tms</i> are selected.</p> <p> <i>Device-name</i> Enter a valid device name.</p> <p>OUTPUT: Specifies whether the output from the command is displayed at the requesting workstation or printed with the job's spooled output.</p> <p> <u>*</u> The output is displayed (if requested by an interactive job) or printed with the job's spooled output (if requested by a batch job).</p> <p> *PRINT The output is printed with the job's spooled output.</p> |
|------------|--|

| | |
|----------|---|
| Examples | <p>WRKTAPDEV DEV (*ALL)</p> <p>This displays the Work with Tape Device display. The list contains an entry for all tape devices defined to MMS/<i>tms</i>.</p> |
|----------|---|

WRKTAPLIB - Work with Tape Library

| Work with Tape Library | | Environment: B/I |
|----------------------------------|-----------------|----------------------------|
| Library device | _____ | Name |
| Volume status | <u>*ALL</u> | *ALL, *ACT, *ERR, *GEN ... |
| + for more values | _____ | |
| System name | <u>*ALL</u> | Name, *LCL, *ALL |
| Output | <u>*</u> | *, *PRINT, *OUTFILE |
| File to receive output | _____ | |
| Library | <u>*LIBL</u> | Name, *LIBL |
| Output member options: | | |
| Member to receive output | <u>*FIRST</u> | Name, *FIRST |
| Replace or add records | <u>*REPLACE</u> | *REPLACE, *ADD |

Purpose

The Work with Tape Library (WRKTAPLIB) command lists all or specific volumes in a tape library. The information listed includes the Job Label, save date/time, expiration date and status. This command provides an easy method of determining the number of scratch volumes in a tape library.

Parameters

- DEV:** Specifies the name of the library device (tape library robot).
- Library-device* Enter the name of the library device associated with the tape library.
- STATUS:** Specifies the status of the volumes to select. Up to 5 statuses can be selected.
- *ALL All volume, regardless of status, are selected.
 - *ACT Active volumes are selected.
 - *ERR Error volumes are selected. Error volumes are created when a save ends abnormally and the data is incomplete.
 - *GEN Generation volumes are selected. Generation volumes are active volumes using retention by generation.
 - *NEW New or volumes unknown to TMS are selected.
 - *SCR Scratch volumes are selected. Scratch volumes are available for use.
 - *SEC Secured volumes are selected. Secured volumes have volume security applied to them.
- SYSTEM:** Specifies the system where the volumes were created.
- *ALL All volumes, regardless of system, are selected.
 - *LCL Volumes created on the local system are selected.
- System-name* Enter a valid system name.

| | |
|----------|---|
| OUTPUT: | Specifies whether the output from the command is displayed at the requesting workstation or printed with the job's spooled output. |
| <u>*</u> | The output is displayed (if requested by an interactive job) or printed with the job's spooled output (if requested by a batch job). |
| *PRINT | The output is printed with the job's spooled output. |
| *OUTFILE | The output is directed to the database output file specified on the "File to receive output" prompt (OUTFILE) parameter. |
| OUTFILE: | Specifies the name and library of the database output file to which the output of the command is directed. If the file does not exist, this command creates a database output file in the specified library. |
| | <u>File to receive output:</u> |
| | <i>File-name</i> Enter the name of the database file where the output is directed. |
| | <u>Library:</u> |
| | *LIBL Searches all libraries in the job's library list until the first match is found for the value in the OUTFILE field. If the file does not exist, it is created in the QGPL library. |
| | <i>Library-name</i> Enter a valid library name. |
| OUTMBR: | Specifies the name of the database file member that receives the output of the command. |
| | <u>Member to receive output:</u> |
| | *FIRST The first member in the file receives the output. If no members exist in the file, the system creates a member with the name of the file specified in the "File to receive output" prompt (OUTFILE) parameter. |
| | <i>Member-name</i> Enter the name of the file member that receives the output. If the name does not exist, the system creates it. |
| | <u>Replace or add records:</u> |
| | *REPLACE The output data replaces any existing records in the specified file member. |
| | *ADD The output data is added to the end of existing records in the specified file member. |

Examples

```
WRKTAPLIB DEV(TAPLIB01) STATUS(*SCR *NEW)
```

This displays the Work with Tape Library panel. The list contains an entry for all scratch and new volumes in library device TAPLIB01.

```
WRKTAPLIB DEV(RML01) STATUS(*ALL) OUTPUT(*PRINT)
```

This prints the Tape Library Volumes report. The report contains an entry for all volumes in library device RML01.

WRKTAPSTS - Work with Tape Status

| | | |
|-----------------------------------|-------------|-----------------------|
| Work with Tape Status (WRKTAPSTS) | | Environment: I |
| Device name | <u>*ALL</u> | Character value, *ALL |
| Wait time | <u>5</u> | 1-99 |

Purpose

The Work with Tape Status (WRKTAPSTS) command lists all or specific active tape devices. This display is automatically refreshed based on the user specified time interval. As the tape is written to or read from, MMS/*tms* updates the display with the data-set name, volume and sequence number.

Parameters

DEV: Specifies the tape device to display. If the device is not active, it does not display.

***ALL** All active tape devices are displayed.

Device-name Enter a valid device name.

WAIT: Specifies the time (in seconds) to wait before the display refreshes. When the display refreshes, it adds any device that went active and removes any device that is no longer active.

5 The display is refreshed every 5 seconds.

1-99 Enter a value from 1 – 99 seconds.

Examples

WRKTAPSTS DEV(*ALL) WAIT(3)

This displays the Work with Tape Status panel. The list contains an entry for all active tape devices defined to MMS/*tms* and it automatically refreshes every 3 seconds.

WRKTAPUSG - Work with Tape Usage

Work with Tape Usage (WRKTAPUSG) Environment: I/B

Device name _____ Character value
 Output * _____ *, *PRINT

| | |
|---------|---|
| Purpose | The Work with Tape Usage (WRKTAPUSG) command lists the densities, initialization formats and device pools for the specified device. |
|---------|---|

| | |
|------------|---|
| Parameters | <p>DEV: Specifies the tape device whose tape usage attributes are selected. The device must be defined to MMS/<i>tms</i>.</p> <p style="padding-left: 40px;"><i>Device-name</i> Enter a valid device name.</p> <p>OUTPUT: Specifies whether the output from the command is displayed at the requesting workstation or printed with the job's spooled output.</p> <p style="padding-left: 40px;"><u>*</u> The output is displayed (if requested by an interactive job) or printed with the job's spooled output (if requested by a batch job).</p> <p style="padding-left: 40px;">*PRINT The output is printed with the job's spooled output.</p> |
|------------|---|

| | |
|----------|--|
| Examples | <p>WRKTAPUSG DEV(TAP01)</p> <p>This displays the Work with Tape Usage panel. The list contains an entry for all densities defined to TAP01.</p> |
|----------|--|

WRKVOL - Work with Volume

| Work with Volume (WRKVOL) | | Environment: I/B |
|--------------------------------|-----------------|---------------------------|
| Volume identifier | <u>*ALL</u> | Character value, *ALL |
| Location code | <u>*ALL</u> | Character value, *ALL |
| Volume Status | <u>*ALL</u> | *ALL, *ACT, *ERR, *GEN... |
| Time period for volume output: | | |
| Starting date and time: | | |
| Beginning date | <u>*BEGIN</u> | Date, *CURRENT, *BEGIN |
| Beginning time | <u>*AVAIL</u> | Time, *AVAIL |
| Ending date and time: | | |
| Ending date | <u>*CURRENT</u> | Date, *CURRENT, *END |
| Ending time | <u>*AVAIL</u> | Time, *AVAIL |
| Job label | <u>*ALL</u> | |
| Text 'description' | <u>*ALL</u> | |
| System name | <u>*ALL</u> | Name, *LCL, *ALL |
| Output | <u>*</u> | *, *PRINT, *OUTFILE |
| File to receive output | | |
| Library | <u>*LIBL</u> | Name, *LIBL |
| Output member options: | | |
| Member to receive output | <u>*FIRST</u> | Name, *FIRST |
| Replace or add records | <u>*REPLACE</u> | *REPLACE, *ADD |
| Volume contents | <u>*NO</u> | *NO, *YES |

Purpose

The Work with Volume (WRKVOL) command lists volumes based on user-defined selection criteria. The information includes the save date/time, status, text, Job Label, retention, expiration date and system. The information can be printed or shown on a display device. Additional volume information, including volume contents can be displayed.

The WRKVOL command can also be used to forecast scratch volumes. If the ending date is greater than today's date, MMS/*tms* automatically recalculates the status of the volumes based on the new end date.

Parameters

| | |
|----------------------|--|
| VOL: | Specifies the volume identifier. |
| <u>*ALL</u> | All volume identifiers are selected. |
| <i>Volume-id</i> | Enter a valid volume identifier. |
| LOC: | Specifies the volume location. |
| <u>*ALL</u> | All volumes, regardless of location, are selected. |
| <i>Location-name</i> | Enter a valid location name. |

STATUS: Specifies the status of the volumes.

***ALL** All volume, regardless of status, are selected.

*ACT Active volumes are selected.

*ERR Error volumes are selected. Error volumes are created when a save ends abnormally and the data is incomplete.

*GEN Generation volumes are selected. Generation volumes are active volumes using retention by generation.

*SCR Scratch volumes are selected. Scratch volumes are available for use.

*SEC Secured volumes are selected. Secured volumes have volume security applied to them.

PERIOD: Specifies the period of time for which the volume data is selected. This parameter contains two lists of two elements each.

Beginning date: One of the following is used to specify the starting date on which or after which the data must have been logged. Any volumes saved before the specified date are not shown.

***BEGIN** The logged data from the beginning of the MMS/*tms* database is selected.

*CURRENT The logged data for the current day and between the specified starting and ending times (if specified) is selected.

Begin-date Enter the beginning date. The date must be specified in the job date format.

Beginning time: One of the following is used to specify the starting time at which or after which the data must have been logged. Any volumes saved before the specified time and date are not selected.

***AVAIL** The logged data that is available for the specified beginning date is selected.

Begin-time Enter the beginning time for the specified beginning date that determines the logged data to be selected. The time is specified in 24-hour format and can be specified with or without a time separator.

Ending date: One of the following is used to specify the ending date before which or on which the data must have been logged. Any volumes saved after the specified date are not selected.

***CURRENT** The last day on which data was logged is the last day for which the logged data is selected.

***END** Used for forecasting scratch volumes. If ***SCR** is specified in the **STATUS** parameter, and a date greater than today's date is entered, the status of all volumes is selected as of this date.

End-date Enter the ending date for which logged data is selected. The date must be specified in the job date format.

Ending time: One of the following is used to specify the ending time before which the data must have been logged. Any volumes saved after the specified time and date are not selected.

***AVAIL** The logged data that is available for the specified ending date is selected.

End-time Enter the ending time for the specified ending date that determines the logged data to be selected. The time is specified in 24-hour format and can be specified with or without a time separator.

JOBLBL: Specifies the Job Label of the volume.

***ALL** All volumes, regardless of Job Label, are selected.

***NONE** All volumes not associated with a Job Label are selected.

***DFT** All volumes associated with the default Job Label are selected.

Job-label Enter a valid Job Label.

TEXT: Specifies the volume text.

***ALL** All volumes, regardless of text, are selected.

*generic** Enter the generic text of the volumes to be selected. A generic name is a character string that contains one or more characters followed by an asterisk (*).

'description' Enter no more than 50 characters of text, enclosed in apostrophes.

| | |
|----------|---|
| SYSTEM: | Specifies the system where the volumes were created. |
| | *ALL All volumes, regardless of system, are selected. |
| | *LCL Volumes created on the local system are selected. |
| | <i>System-name</i> Enter a valid system name. |
| OUTPUT: | Specifies whether the output from the command is displayed at the requesting workstation or printed with the job's spooled output. |
| | * The output is displayed (if requested by an interactive job) or printed with the job's spooled output (if requested by a batch job). |
| | *PRINT The output is printed with the job's spooled output. |
| | *OUTFILE The output is directed to the database output file specified on the "File to receive output" prompt (OUTFILE) parameter. |
| OUTFILE: | Specifies the name and library of the database output file to which the output of the command is directed. If the file does not exist, this command creates a database output file in the specified library. |
| | <u>File to receive output:</u> |
| | <i>File-name</i> Enter the name of the database file where the output is directed. |
| | <u>Library:</u> |
| | *LIBL Searches all libraries in the job's library list until the first match is found for the value in the OUTFILE field. If the file does not exist, it is created in the QGPL library. |
| | <i>Library-name</i> Enter a valid library name. |
| OUTMBR: | Specifies the name of the database file member that receives the output of the command. |
| | <u>Member to receive output:</u> |
| | *FIRST The first member in the file receives the output. If no members exist in the file, the system creates a member with the name of the file specified in the "File to receive output" prompt (OUTFILE) parameter. |
| | <i>Member-name</i> Enter the name of the file member that receives the output. If the name does not exist, the system creates it. |

Replace or add records:

***REPLACE** The output data replaces any existing records in the specified file member.

*ADD The output data is added to the end of existing records in the specified file member.

CONTENTS: Specifies if the selected volume contents should be printed when **OUTPUT(*PRINT)** is specified. If the volume contents reside on a remote system, they are retrieved and printed.

***NO** Volume contents are not printed.

*YES Volumes contents are printed.

Examples

```
WRKVOL VOL(*ALL) PERIOD((080104) (090104)) JOBLEL(DAILY)
```

This displays the Work with Volume panel. The list contains an entry for all volumes that were saved from 08/01/04 to 09/01/04, and were created with Job Label DAILY.

Chapter 18

Install/Uninstall Instructions

This chapter describes the install/uninstall processes. The installation of the MMS Tape Management is easy and only takes a few minutes to load and setup. Please read and follow these instructions carefully to avoid problems and ensure trouble free product performance.

Install Process

The installation process loads/updates the product from CD to disk. To install, follow the instructions in the **Readme** text file provided on the CD. These instructions guide you through the installation process. If this is a first-time install, the installation process creates the following libraries on the system.

- LXI Base and Support Programs
- LXITMS MMS Tape Management Programs
- LXITMS400 MMS Tape Management Files

Upgrading OS/400

When upgrading from one OS/400 release to another, perform the following steps. This installs product specific changes, which may be required for the new OS/400 release.

```
CHGPRDSTS *TMS *DETACH
```

```
CHGPRDSTS *TMS *ATTACH
```

Changing the iSeries

Moving this product from one iSeries to another or upgrading to a different iSeries model requires a new license key. Once the product moves to the new iSeries or the iSeries is upgraded to a different model, call LXI Corp. for a new license key. No install is required.

Uninstall Process

To remove **TMS** from the system, perform the following:

```
CHGPRDSTS *TMS *DETACH
ENDSBS QLXI *IMMED
DLTLICPGM LICPGM(0LX0000) OPTION(91)
```

Entering the License Key

MMS Tape Management (MMS/*tms*) requires a valid license key in order to function. The license key is based on the serial number and model of the iSeries. To enter a license key, perform the following:

- ___ Step 1. **GO LXI/LXI**
- ___ Step 2. Tab to the **SETUP** option on the menu bar.
- ___ Step 3. Press **Enter** to view the options available.
- ___ Step 4. Select "**Work with License Info.**".
- ___ Step 5. Select **Option 1** for feature **9110**.
- ___ Step 6. Enter the supplied license key.

Trial Period

The trial period is valid for a period of 30 days from the time the product is *first* used. In order for MMS/*tms* to continue tracking and protecting tapes after the 30-day trial period, a license key must be entered.

Permanent License Key

Once the software has been purchased and payment received by LXI Corp., a ***permanent license key*** will be issued. This permanent license key must be entered into the software to ensure that the product continues without interruption.

The license key remains valid unless the iSeries serial or model number changes. When a change occurs, you should notify LXI Corp. to get another license key.

Chapter 19

Advanced Topics

The QLXI Subsystem

MMS/*tms* communications uses the **QLXI** subsystem. If MMS/*tms* is communicating with other systems or if you have other LXI modules that use the subsystem, it is recommended that you add the **QLXI** subsystem to the startup program, **QSTRUP**. The **QLXI** subsystem description is located in the **LXI** library.

MMS/*tms* and SAVSTG

MMS/*tms* does not track the IBM Save Storage (**SAVSTG**) command. Media used for this function can be added to the MMS/*tms* database through the Add Volume ([ADDVOL](#)) command. For more information about the Add Volume command, see [Chapter 9, Volume Management](#).

Reorganizing the Database

MMS/*tms* reuses deleted records. Reorganizing the database files should not be required; however, a periodic reorganize ensures that the number of deleted records remains small. **BEFORE REORGANIZING ANY OF THESE FILES, MAKE SURE THAT NO TAPE ACTIVITY IS OCCURRING OR WILL OCCUR UNTIL THE REORGANIZE PROCESS IS COMPLETE.** It is recommended that this process be submitted to batch or scheduled in a job scheduler. To reorganize the files in batch, enter the following:

```
SBMJOB  CMD(RGZPFM  FILE(LXITMS400/LICMNRK)
SBMJOB  CMD(RGZPFM  FILE(LXITMS400/LIDL0MST)
SBMJOB  CMD(RGZPFM  FILE(LXITMS400/LID0MMST)
SBMJOB  CMD(RGZPFM  FILE(LXITMS400/LILNKMST)
SBMJOB  CMD(RGZPFM  FILE(LXITMS400/LIOBJMST)
SBMJOB  CMD(RGZPFM  FILE(LXITMS400/LIVOLUME)
```

Clearing the Database

The MMS/*tms* database files can be cleared for restart purposes. This procedure should be used with caution. It removes all volumes and volume contents from the database files and allows the restarting of MMS/*tms* with an empty database. To clear the MMS/*tms* database files, perform the following procedure:

```
CLRPFM FILE(LXITMS400/LICMNWRK)
CLRPFM FILE(LXITMS400/LIDLOMST)
CLRPFM FILE(LXITMS400/LIJOBLBL)
CLRPFM FILE(LXITMS400/LILNKMST)
CLRPFM FILE(LXITMS400/LIOBJMST)
CLRPFM FILE(LXITMS400/LIVOLUME)
```

Saving the Database

The MMS/*tms* database files reside in the **LXITMS400** library. Since the files are updated concurrently with tape processing, special considerations must be taken into account. This library must be saved when no other tape activity is active. The database files that are actually saved on tape only include the initial volume for the current **LXITMS400** save since any remaining volumes and contents are not be updated in the database until **AFTER** the save has completed writing to the tape. Libraries **LXI** and **LXITMS** do not need to be saved unless Program Temporary Fixes (**PTF**) or updates have been applied to either of these libraries.

Modifying Option 21

Option 21 from the IBM Save Menu is used to perform a Save System (**SAVSYS**), Save Non-System (**SAVLIB *NONSYS**), Save Document Library Objects (**SAVDLO**), and Save Hierarchical File System Files (**SAV**). The MMS/*tms* Cycle Volume (**CYCLE**) command can be added to this option by retrieving the CL source to program **QMNSAVE** and adding the **CYCLE** command to it. When complete, re-compile it back into library **QSYS**. You may want to rename the original **QMNSAVE** prior to compiling the new one. To retrieve the source for **Option 21** into the **QCLSRC** file in library **QGPL**, perform the following procedure:

```
RTVCLSRC PGM(QSYS/QMNSAVE) SRCFILE(QGPL/QCLSRC)
```

Modifying the MMS/*tms* Message File

Some inquiry messages issued by MMS/*tms* are in message file **TMSMSGF** in **LXITMS400**. These messages, which start with **TMS**, can be modified, if required. When MMS/*tms* is re-installed, the message file is replaced and any required changes need to be reapplied.

Last Used Date

File **LIVOLUME** in library **LXITMS400** contains two fields, which do not display on any report or panel. These fields allow the user to determine how many times a tape was used since the save date and the last date it was accessed. These fields are reset when a tape is initialized. This information resides in the following fields:

```
VLCDAT = Last date accessed
VL#USD = Number of times accessed since the last save
```

Disaster Recovery Considerations

When reloading OS/400 and user libraries, perform the following procedures.

Install OS/400, then...

Before restoring any user libraries.

```
RMVEXITPGM EXITPNT(QIBM_QTA_TAPE_TMS) FORMAT(TMS00200) +
PGMNBR(1)
```

After all libraries have been restored.

```
LXI/CHGPRDSTS *TMS *DETACH
LXI/CHGPRDSTS *TMS *ATTACH
```

Setting up DDM over TCP/IP

MMS/*tms* uses DDM for the Compare Volume ([CMPVOL](#)) command and for inquiries and reports. To set up DDM over TCP/IP perform the following:

- Prompt the Change DDM TCP/IP Attributes (**CHGDDMTCPA**) command and ensure the parameters are as follows:

```
CHGDDMTCPA AUTOSTART(*YES) PWDRQD(*NO)
```

- Ensure that the following commands are part of the IPL startup program (**QSTRUP**).

```
STRTCP STRSVR(*YES) STRIFC(*YES)
STRHOSTSVR SERVER(*DATABASE or *ALL)
STRTCP SVR SERVER(*DDM)
```

- If a password is required when using DDM over TCP/IP, perform the following:

Change the Retain Server Security Data (**QRETSVRSEC**) system value as follows:

```
CHGSYSVAL SYSVAL(QRETSVRSEC) VALUE('1')
```

Use the Add Server Authority Entry (**ADDSVRAUTE**) command to add every user that will use the Compare Volume ([CMPVOL](#)) or access remote systems' data. Use uppercase for all values except the password.

```
ADDSVRAUTE USRPRF(*CURRENT or user-name) +
SERVER(QDDMSERVER) +
USERID(user-name) +
PASSWORD(user password on remote system)
```

Note: *If the password for the user profile changes, use the Change Server Authority Entry (**CHGSVRAUTE**) command to update the password for the server entry.*

Chapter 20

MMS/tms and TSM

MMS/*tms* tracks tapes created by Tivoli Storage Manager (TSM). Since TSM saves data from remote systems, the detailed volume content information resides on the remote and is managed by TSM. The exit programs enable MMS/*tms* to be updated based on the TSM function being initiated. This chapter assumes that basic knowledge on the setup and use of TSM already exists. For information on the setup and use of TSM, refer to the appropriate TSM documentation.

Defining the Exit Programs

The exit programs must be defined from an TSM administrative client session. Detailed information covering this topic can be found in the TSM Administrators Guide (SH26-4008) in the Managing Drives, Libraries and Exit Programs section.

The DEFINE command must be issued for each exit program. The following example shows how to define the TSM exit programs.

```
DEFINE    EXIT MOUNT          LXITSM/AI$MNTC
DEFINE    EXIT DISMOUNT       LXITSM/AI$DMNTC
DEFINE    EXIT DELETION        LXITSM/AI$DLTC
DEFINE    EXIT EXPIRATION      LXITSM/AI$EXPC
```

Additional definitions of other items are required to trigger the exit programs. These additional items, shown below, should be entered in the listed sequence. The following steps are examples of some essential TSM definitions. Not all definitions may be required for your application.

Note: *Device types other than 3490, 3590 and 8mm may be defined.*

```
DEFINE LIBRARY USRDFN_MNT LIBTYPE=USRDFN DRIVESELECTION=EXIT
```

This specifies that the exit program determines the DRIVE SELECTION. The exit program allocates the drive before use and de-allocates the drive when the tape function has completed. Ensure that the density for the drives defined to MMS/*tms* is appropriate for the format defined in the TSM DEFINE DEVCLASS command. For additional information on device management, refer to [Chapter 6, Managing Devices](#).

To manage the devices manually or through TSM, refer to the TSM documentation for the **DRIVESELECTION** values.

```

DEFINE DEVCLASS   USRDFN_8MM  DEVTYPE=8MM    FORMAT=8700
                   LIBRARY=USRDFN_MNT    MOUNTR=3
                   PREFIX=TSM8MM

DEFINE DEVCLASS   USRDFN_3490 DEVTYPE=CART    FORMAT=3490
                   LIBRARY=USRDFN_MNT    MOUNTR=3
                   PREFIX=TSM3490

DEFINE DEVCLASS   USRDFN_3590 DEVTYPE=3590    FORMAT=3590
                   LIBRARY=USRDFN_MNT    MOUNTR=3
                   PREFIX=TSM3590

```

The **PREFIX** value determines which MMS/*tms* Job Label to use. The Job Label must be defined before the TSM exits are used. To define Job Labels, use the Work with Job Label ([WRKJOBLBL](#)) command.

```

           STGPOOL           DEVCLASS
DEFINE STGPOOL  USRDFN_8MM    USRDFN_8MM    MAXSCRATCH=100000000
DEFINE STGPOOL  USRDFN_3490  USRDFN_3490  MAXSCRATCH=100000000
DEFINE STGPOOL  USRDFN_3590  USRDFN_3590  MAXSCRATCH=100000000

```

```

           DOMAIN
DEFINE DOM      USRDFN_8MM
DEFINE DOM      USRDFN_3490
DEFINE DOM      USRDFN_3590

```

```

           DOMAIN           POLICY
DEFINE POL     USRDFN_8MM    USRDFN_8MM
DEFINE POL     USRDFN_3490  USRDFN_3490
DEFINE POL     USRDFN_3590  USRDFN_3590

```

```

           DOMAIN           POLICY           MGMTCLASS
DEFINE MGMTCLASS  USRDFN_8MM    USRDFN_8MM    USRDFN_8MM
DEFINE MGMTCLASS  USRDFN_3490  USRDFN_3490  USRDFN_3490
DEFINE MGMTCLASS  USRDFN_3590  USRDFN_3590  USRDFN_3590

```

```

           DOMAIN           POLICY           MGMTCLASS
ASSIGN DEFMGMTCLASS  USRDFN_8MM    USRDFN_8MM    USRDFN_8MM
ASSIGN DEFMGMTCLASS  USRDFN_3490  USRDFN_3490  USRDFN_3490
ASSIGN DEFMGMTCLASS  USRDFN_3590  USRDFN_3590  USRDFN_3590

```

```

           DOMAIN           POLICY           MGMTCLASS
DEFINE COPYGROUP     USRDFN_8MM    USRDFN_8MM    USRDFN_8MM
                   TYPE=BACKUP    DESTINATION=USRDFN_8MM
DEFINE COPYGROUP     USRDFN_3490  USRDFN_3490  USRDFN_3490
                   TYPE=BACKUP    DESTINATION=USRDFN_3490
DEFINE COPYGROUP     USRDFN_3590  USRDFN_3590  USRDFN_3590
                   TYPE=BACKUP    DESTINATION=USRDFN_3590

```

```

DEFINE COPYGROUP      USRDFN_8MM      USRDFN_8MM      USRDFN_8MM
      TYPE=ARCHIVE DESTINATION=USRDFN_8MM
DEFINE COPYGROUP      USRDFN_3490     USRDFN_3490     USRDFN_3490
      TYPE= ARCHIVE DESTINATION=USRDFN_3490
DEFINE COPYGROUP      USRDFN_3590     USRDFN_3590     USRDFN_3590
      TYPE= ARCHIVE DESTINATION=USRDFN_3590

      DOMAIN          POLICY
VALIDATE POLICYSET    USRDFN_8MM      USRDFN_8MM
VALIDATE POLICYSET    USRDFN_3490     USRDFN_3490
VALIDATE POLICYSET    USRDFN_3590     USRDFN_3590

      DOMAIN          POLICY
ACTIVATE POLICYSET    USRDFN_8MM      USRDFN_8MM
ACTIVATE POLICYSET    USRDFN_3490     USRDFN_3490
ACTIVATE POLICYSET    USRDFN_3590     USRDFN_3590

      NODE           DOMAIN
UPDATE NODE           node-name     DOMAIN=USRDFN_8MM
      OR
UPDATE NODE           node-name     DOMAIN=USRDFN_3490
      OR
UPDATE NODE           node-name     DOMAIN=USRDFN_3590

```

Special Implementation Considerations

All TSM defined storage pools, which are used in conjunction with MMS/*tms*, must have a maximum scratch value (**MAXSCRATCH**) defined. This prevents TSM from selecting volumes that may fail validation when a volume is compared to the volume ranges specified in MMS/*tms*. TSM accepts a range from 1 to 100000000 for this parameter. It is recommended that 100000000 be used to minimize future maintenance of the storage pool's definition.

The MMS/*tms* Cycle Volume (**CYCLE**) command is issued when the TSM mount exit program is invoked. The Job Label must be defined to MMS/*tms* and referenced within the DEVCLASS volume prefix parameter. The Usage portion of the **POOL** parameter should specify ***NEXT**. Refer to the Add Job Label (**ADDJOBLBL**) command for details on the **POOL** parameter.

The MMS/*tms* TSM interface message file must be visible to the exit programs. Use the Change Job Description (**CHGJOB**) command to add library LXITSM to the end of the initial library list (**INLLIBL**) parameter in the QADSM job description. This job description resides in library QADSM.

Chapter 21

Additional Interfaces...

MMS/*tms* supports interfaces to the following products:

- Computer Associates' BrightStor Portal
- EMC CopyPoint

BrightStor® Portal

MMS/*tms* provides an interface to Computer Associates' BrightStor Portal. This interface allows MMS/*tms* information to be viewed through a single point of control. Refer to the **Readme** document, which is supplied with the interface, for installation and usage instructions.

EMC CopyPoint®

MMS/*tms* provides an interface to the EMC CopyPoint product. This interface provides the backend media management and automation for an end-to-end high availability, business continuity and disaster recovery solution.

Install Process

Perform the following steps to install the MMS/*tms* interface to the EMC CopyPoint Software.

1. Sign on as QSECOFR
2. `RSTLICPGM LICPGM(0LX0000) DEV(device-name) OPTION(96)`

Uninstall Process

Perform the following steps to remove the MMS/*tms* interface to the EMC CopyPoint Software.

1. Sign on as QSECOFR
2. `DLTLICPGM LICPGM(0LX0000) OPTION(96)`

EMC Interface Considerations

The following rules apply when using this interface.

- MMS/*tms* V5R3M0 or greater must be installed and attached.
- The LXITMS library must be followed by the EMCCPT library in the user portion of the library list.
- The level of information tracked is based on the retrieval level specified in the MMS/*tms* Job Label. Refer to [Chapter 13, Using Data Retrieval](#), for additional information.
- Member tracking is not supported.
- When tracked, the save command specified in the MMS/*tms* database corresponds to the actual IBM save command used. Refer to the following chart.

| CopyPoint Command | Corresponding IBM Command |
|-------------------|---------------------------|
| SV | SAV |
| SVDOC | SAVDLO |
| SVOBJ | SAVOBJ |
| SVLIB | SAVLIB |

Chapter 22

Troubleshooting Guide

The purpose of this guide is to list commonly asked questions regarding the use of MMS Tape Management. Each question and answer is designed to resolve specific situations as quickly as possible. This guide should be the first place a user looks when encountering any type of function that does not appear to operate as expected. If, after reviewing this guide, a question still exists, contact LXI Product Support for assistance.

1. I entered the license key and MMS/*tms* says it is invalid.

The license key is date sensitive. If the evaluation time has elapsed, another license key is required. If you are entering a permanent license key, make sure that you entered the license key correctly. Additional information can be found in [Chapter 18, *Install/Uninstall Instructions*](#). If the code still does not work, call LXI Corp. Product Support.

2. I performed a save and MMS/*tms* did not track the tape.

The most common cause is that the product is detached. Use the Change Product Status ([CHGPRDSTS](#)) command to check the status of MMS/*tms*. If MMS/*tms* is attached, the license key may no longer be valid. Check the **QSYSOPR** message queue for MMS/*tms* expiration messages.

3. I did a save and the expiration date is 010100 even though it should have been something else.

You used the **CPYTOTAP** command with a tape file that has ***NONE** specified as the expiration date. Change the tape file expiration date to ***PERM**. MMS/*tms* only calculates the expiration date if the expiration date on the command is ***PERM**.

4. I specified *OBJ for the data retrieval level in a Job Label but all I get is library level.

Object and/or member level information is not available for the following commands: **CPYFRMTAP**, **CPYTOTAP**, **SAVSYS**, **SAVCFG** and **SAVSECDTA**. Additional information can be found in [Chapter 12, *Customizing MMS/tms*](#).

5. We're using a StorageTek 9710 direct-attach tape library and MMS/*tms* will not mount any tapes.

The tape devices must be defined in the Device Definition as a ***STKDA** along with the name of the library device. To use a library, the Job Labels must specify a volume range. If the tapes in the library are new, initialize them with the MMS/*tms* Initialize Tape ([INZTAP](#)) command, otherwise use the Update Tape library ([UPDTAPLIB](#)) command to update the MMS/*tms* volume information.

6. CPIC communication is not working between multiple MMS/*tms* systems.

Ensure that subsystem **QLXI** is active. Use the Work with Communication Links ([WRKCMNLNK](#)) command to display all systems defined to MMS/*tms* and ensure that they have been defined correctly. Use **Option 6** to test the link. Ensure that the **LXI** user profile is enabled and that the password has not expired. If the password has expired, change the password to "TEST" and then change it to "LXI". Changing the expired password from "LXI" to "LXI" does not register as a change in OS/400. Do not use a password other than "LXI" (other passwords will not work). Additional information can be found in [Chapter 10](#), *The MMS/*tms* Network*.

7. How do I get a volume report in volume sequence?

To get a volume report in volume sequence, enter ***SCR** in the status parameter of the Display Volume ([DSPVOL](#)) or Work with Volume ([WRKVOL](#)) command and ***END** as the ending date. This lists all volumes in volume identifier sequence.

8. I keep getting a message that the device I'm using for RTVVOL doesn't exist. What does this mean?

The device that you're specifying on the Retrieve Volume ([RTVVOL](#)) command is not defined to MMS/*tms*. Use the Work with Tape Device ([WRKTAPDEV](#)) command to define the device and then try the **RTVVOL** again.

9. I do not want to use the device allocation routines. Can this be accomplished?

Yes. Specify **SHARE(*NO)** for the device. Use the Work with Tape Device ([WRKTAPDEV](#)) command to change the Device Definition.

10. I have a StorageTek tape library and tried to do a restore but MMS/*tms* didn't mount the volume. Why?

The most common cause is that **FUNCTION(*WRITE)** has been specified for the device being used for the restore function. Use the Work with Tape Device ([WRKTAPDEV](#)) command to change the Device Definition to **FUNCTION(*ALL)**.

11. I did a RTVVOL and the volume didn't get added to the database. MMS/*tms* is attached, the license key is valid, the device is defined and the volume is not being filtered. What did I miss?

The most common cause is that **FUNCTION(*WRITE)** has been specified for the device being used for the retrieve function. Use the Work with Tape Device ([WRKTAPDEV](#)) command to change the Device Definition to **FUNCTION(*ALL)**.

12. When defining the tape pools for a tape library, should the pool only consist of volumes in the tape library or should the entire range be specified even though some tapes may not be in the tape library?

Specify the entire range. MMS/*tms* verifies that the tape is in the tape library before mounting it.

13. When do I use the Change Tape Library command with STATUS(*SEQ)?

Before you put the system in restricted state to perform saves. This command only needs to be used if you are using one of the following:

- Memorex/Telex tape library
- StorageTek - Direct Attach tape library

When the backups are finished, issue the Change Tape Library ([CHGTAPLIB](#)) command with **STATUS(*RANDOM)**. This returns the library to random or library mode.

14. Can MMS/*tms* support multiple tape libraries on the same iSeries?

Yes.

15. Can MMS/*tms* support multiple iSeries on the same tape library?

Yes.

Chapter 23

Electronic Software Support

Electronic Software Support (ESS) is a module within all LXI Corp. products that provides LXI Technical Support staff access to your system, upon your approval, to help isolate and resolve issues. This process helps ensure that your product is working correctly and performing to design standards.

Online support allows an LXI product technician to sign on to your system for diagnostic purposes. This method is beneficial when issues cannot be resolved easily. Online support requires that you provide LXI with a user profile, password and virtual device for system access.

Setting up ESS

Before using **ESS**, some initial setup must be performed. This setup includes defining any special characters or numbers that must be dialed prior to dialing the LXI Corp. Product Support number, determining the modem type and optionally defining the resource name and line speed. This setup only needs to be performed once or if the information changes.

To access the ESS main menu, type **GO LXI/ESS** on an OS/400 command line and press **Enter**.

Updating the Configuration Data

Select **Option 1** from the Setup pull-down menu. This displays the Configuration Data panel. This panel specifies the LXI Product Support phone number and the modem type parameter.

Do not alter the LXI Corp. phone number unless you need to add special characters in front of it for time delay or outside line purposes.

If an **external** modem is specified in the modem type parameter, press **Enter**. This displays two additional parameters which are the resource number of the line being used and the speed of the modem. Review and optionally change the information and press **Enter**.

If an **internal** modem is specified, press **Enter**.

```

Configuration Data
Type changes, press Enter.
Vendor name . . . . . LXI Corp.
Telephone number . . . . . 214-260-9002
Connection number . . . . . 9-972-556-2136
Modem type . . . . . *EXTERNAL
Line speed . . . . . 9600
Resource name . . . . . LIN041

F3=Exit  F9=Command line  F12=Cancel
Copyright LXI Corp. 1985, 2006

```

Requesting Online Support

To start online support, enter **Option 1** from the Electronic Software Support menu. This displays the Customer Information panel. Enter the required information and press **Enter**. To start the **ESS** online support process, press **F6**.

```
Setup  Help
-----
ESS      Electronic Software Support

Select one of the following:

    1. Start On-line Support

Selection or command
=> _____

F3=Exit F4=Prompt F9=Refresh F12=Cancel F14=Sta

QSECOFR      Customer Information      System: LXI#CORP
Type changes, press Enter.
Company name . . . . . LXI Corp.
Contact . . . . . Project Manager
Address . . . . . 1925 W. John Carpenter Fwy
                   Suite 485
City/State . . . . . Irving, TX
Country . . . . . USA
Zip code . . . . . 75063
Telephone number . . . . . 2142609002
Fax number . . . . . 2142609019

F3=Exit F6=Connect F9=Command line F12=Cancel
Copyright LXI Corp. 1985, 2006
```

ESS Considerations

When using an external modem, **ESS** leaves the line varied on. Due to processing restrictions, **ESS** cannot vary the line off.

Index

A

| | |
|--|---|
| ADDJOBLBL - Add Job Label..... | 17-6 |
| ADDRTVLVL - Add Retrieval Level | 17-12 |
| ADDTAPDEV – Add Tape Device | 17-14 |
| ADDVOL – Add Volume | 17-17 |
| ALCTAPDEV – Allocate Tape Device | 17-19 |
| Attaching LXI <i>ms</i> | 5-1, 8-2, 14-14, 14-16, 14-17, 14-20, 14-24, 22-3 |
| Audit | |
| scanning the log..... | 15-3 |

B

| | |
|-------------------------|-----|
| Before You Install..... | 1-5 |
|-------------------------|-----|

C

| | |
|---|-------|
| CHGCMNLNK - Change Communication Link | 17-21 |
| CHGJOBLBL - Change Job Label | 17-24 |
| CHGPRDOPT - Change Product Option | 17-30 |
| CHGPRDSTS - Change Product Status | 17-33 |
| CHGRTVLVL - Change Retrieval Level | 17-34 |
| CHGTAPDEV - Change Tape Device..... | 17-36 |
| CHGTAPLIB - Change Tape Library..... | 17-39 |
| CHGTAPUSG - Change Tape Usage | 17-41 |
| CHGVOL - Change Volume..... | 17-45 |
| CHGVOLSEC - Change Volume Security | 17-47 |
| CLRVOL - Clear Volume..... | 17-48 |
| CMPVOL - Compare Volume | 17-49 |
| Command security | 1-5 |
| Communication | |
| adding..... | 10-3 |
| changing | 10-3 |
| deleting..... | 10-4 |
| ending..... | 10-5 |
| journal..... | 10-8 |
| overview | 10-1 |
| profile | 10-6 |
| starting..... | 10-5 |
| testing | 10-4 |
| Communication transactions | |
| viewing..... | 10-5 |
| CYCLE - Cycle Volume..... | 17-50 |

D

| | |
|-------------------|------|
| Database | |
| clearing..... | 19-2 |
| reorganizing..... | 19-1 |
| saving | 19-2 |
| Device | |
| changing | 6-2 |
| deleting..... | 6-2 |

| | |
|--|-----------------------|
| monitoring | 6-10 |
| Device sharing | |
| allocation | 6-5 |
| concepts | 6-5 |
| de-allocation | 6-5 |
| examples | 6-6 |
| DLCTAPDEV - De-allocate Tape Device | 17-52 |
| DLTCMNLNK - Delete Communication Link | 17-53 |
| DLTJOBLBL - Delete job Label | 17-54 |
| DLTJOBLBL - Delete Job Label | 17-54 |
| DLTRTVLVL - Delete Retrieval Level | 17-55 |
| DLTTAPDEV - Delete Tape Device | 17-56 |
| DLTVOL - Delete Volume | 17-57 |
| DSPCMNLNK - Display Communication Link | 17-58 |
| DSPJOBLBL - Display Job Label | 17-59 |
| DSPSAVDLO - Display Saved DLO | 17-60 |
| DSPVOL - Display Volume | 17-72 |
| DSPVOLDTA - Display Volume Data | 17-77 |
| DSPVOLFMT - Display Volume Format | 17-78 |
| DSPVOLINF - Display Volume Information | 17-79 |
| DUPVOL - Duplicate Volume | 17-80 |
| E | |
| EJTVOL - Eject Volume | 17-83 |
| ENDCMNLNK - End Communication Link | 17-86 |
| ENTVOL - Enter Volume | 17-87 |
| Expiration date | |
| calculating | 1-5 |
| changing | 9-3 |
| F | |
| File Size Considerations | 13-9 |
| I | |
| IBM commands | 1-6 |
| Initialization | |
| *NL tapes | 6-8 |
| concepts | 6-7 |
| requirements | 6-7 |
| Installation | 1-2 |
| INZTAP - Initialize Tape | 17-88 |
| J | |
| Job label | |
| changing | 9-3 |
| Job Scheduler | 2-4, 16-2, 16-3, 16-4 |
| M | |
| Media and Storage Extension | 1-5 |
| Menus | |
| bars | 4-2 |
| GUI | 4-2 |
| menu groups | 4-1 |

| | |
|--|------------|
| security | 4-1 |
| O | |
| Option 21 | 19-2 |
| Options | |
| default location name | 12-2 |
| default retrieval level..... | 12-2, 13-3 |
| overview | 12-1 |
| P | |
| Printer file | |
| changing | 16-3 |
| PRTRCYVOL - Print Recovery Volumes | 17-92 |
| PRTVOLLBL - Print Volume Label..... | 17-94 |
| PRTVOLSTS - Print Volume Status..... | 17-95 |
| R | |
| Recovery | |
| overview | 11-1 |
| restoring a DLO..... | 11-2 |
| restoring an object | 11-4 |
| Reports | |
| accessing Report menu | 16-2 |
| Changing printer file..... | 16-3 |
| changing schedule | 16-4 |
| deleting schedule | 16-4 |
| printing | 16-2 |
| scheduling..... | 16-4 |
| Retention | |
| adding | 7-3 |
| attributes | 7-3 |
| by days..... | 7-2 |
| by generations..... | 7-2 |
| changing | 7-3 |
| days and generations..... | 7-2 |
| deleting | 7-3 |
| overview | 7-1 |
| requirements | 7-5 |
| using CYCLE | 7-5, 17-50 |
| using SBMJOB..... | 7-7 |
| Retrieval level | |
| considerations..... | 13-9 |
| levels..... | 13-4, 13-9 |
| overview | 13-1 |
| requirements | 13-2 |
| save file support..... | 13-2 |
| user defined | 13-3 |
| RTVJOBLBL - Retrieve job Label | 17-96 |
| RTVVOL - Retrieve Volume..... | 17-98 |
| S | |
| SAVSTG – Save Storage | 19-1 |
| SCNLOG - Scan Log | 17-100 |

| | |
|--|-----------------------|
| Scratch | |
| forecasting | 2-3 |
| STRCMNLNK - Start Communication Link | 17-103 |
| Subsystem | |
| ending | 10-8 |
| Startup program | 10-8, 19-1 |
| System defaults | 1-5 |
| T | |
| Tape libraries | |
| IBM 3494 | 6-2, 8-4, 14-5, 16-16 |
| synchronizing | 14-2 |
| Tape library | |
| overview | 14-1 |
| Tape pool | |
| *LAST | 17-10, 19-3 |
| attributes | 8-2 |
| mounting options | 8-2 |
| overview | 8-1 |
| Tape usage | |
| changing | 6-4 |
| Troubleshooting | 1-2, 22-1 |
| TSTCMNLNK - Test Communication Link | 17-104 |
| U | |
| UPDTAPLIB - Update Tape Library | 17-106 |
| V | |
| Volume | |
| adding | 9-2 |
| changing | 9-3 |
| clearing | 9-3 |
| contents | 9-4, 14-3 |
| deleting | 9-4 |
| displaying | 9-4 |
| history | 9-5 |
| retrieving | 9-5 |
| Unique identifiers | 1-5, 1-6 |
| Volume management | |
| commands | 9-2 |
| overview | 9-1, 9-2, 19-1 |
| Volume Text | |
| changing | 9-3 |
| W | |
| WRKPRTF - Work with Printer Files | 17-109 |
| WRKSAVDLO - Work with Saved DLO | 17-111 |
| WRKTAPLIB - Work with Tape Library | 17-124 |
| WRKTAPSTS - Work with Tape Status | 17-127 |
| WRKTAPUSG - Work with Tape Usage | 17-128 |
